

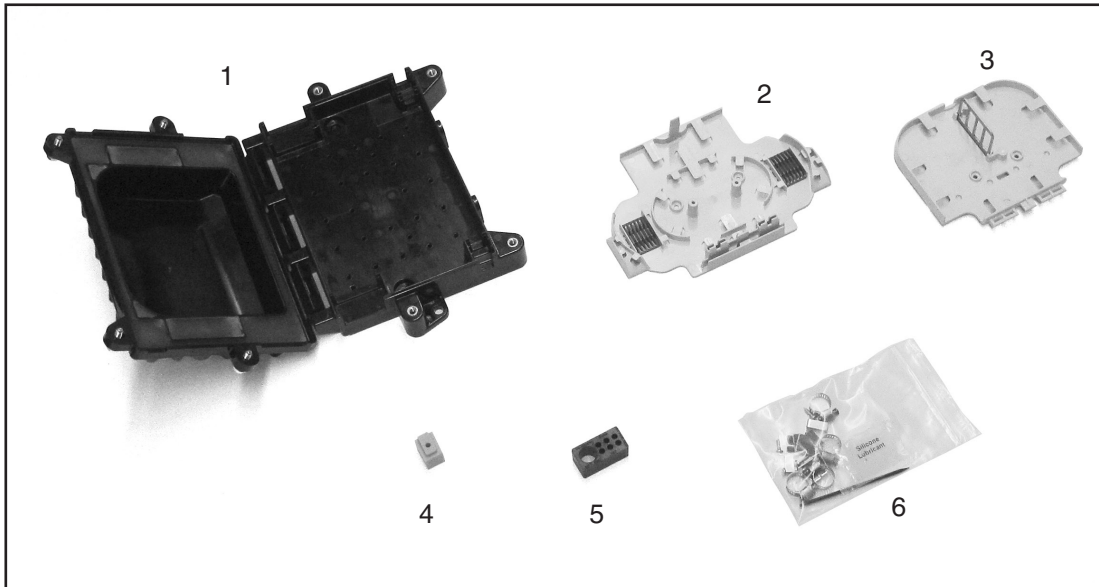

COYOTE® DTC4 (Drop Termination Closure)

Be sure to read and completely understand this procedure before applying product. Be sure to select the proper PREFORMED™ product before application.



NOMENCLATURE

- 1. Base with Cover (1)
- 2. Splice Organizer (1)
- 3. Bulkhead Tray
(with Splice and Adapters Organizer) (1)

- 4. Small Grommet (4)
- 5. Large Grommet (2)
- 6. Small Parts Bag (1)

TOOLS REQUIRED

- 3/8" & 7/16" can wrench or socket
- Fiber optic cable opening tools
- 1/4" Nut driver or screwdriver
- Phillips Head Screwdriver
- Snips

COYOTE® DTC 4/6 Mounting Bracket Kits		
Catalog Number	Description	Kit Image
8004109	COYOTE DTC 4/6 Pole/Wall Mount Bracket Kit	
8004110	COYOTE DTC 4/6 Cable Storage Bracket Kit	
8004111	COYOTE DTC 4/6 Aerial Mounting Bracket Kit – Strand Applications	
8004112	COYOTE DTC 4/6 Aerial Mounting Bracket Kit – ADSS Applications	

General Base Preparation

Step #1 Install the fiber organizer into the base with the self-tapping screws provided.



Step #2 Determine the cable entry locations for cut applications as shown below.

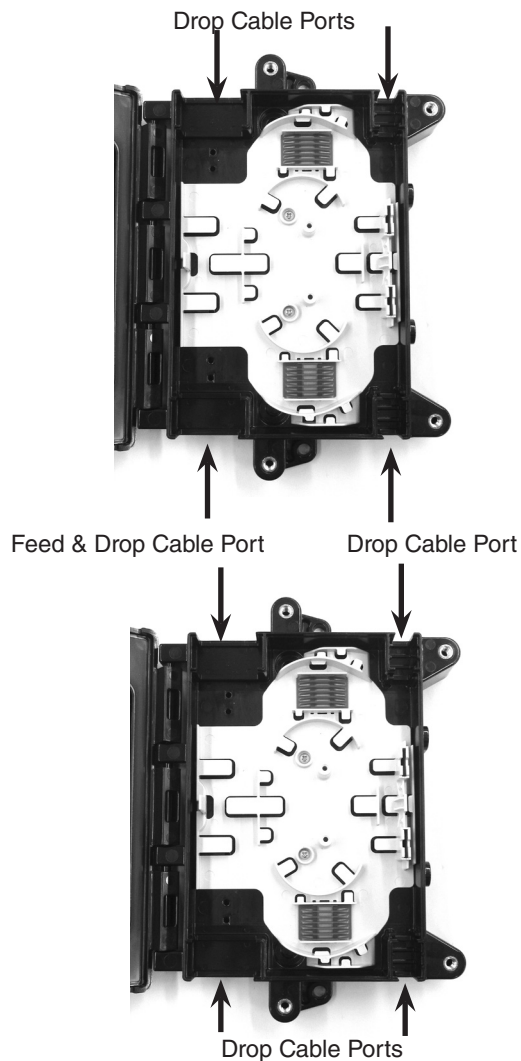

Step #3 Determine the cable entry locations for in-line applications as shown below.

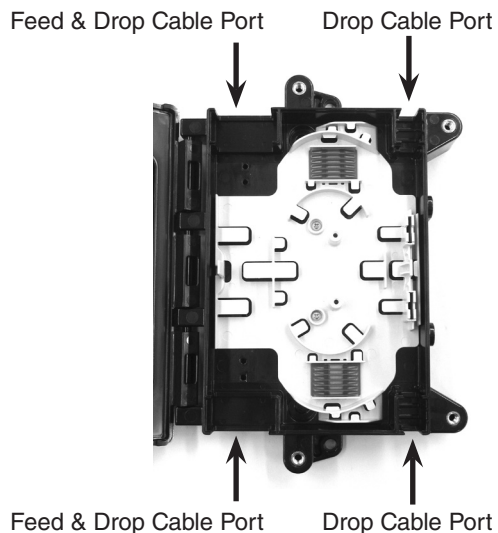

Step #4 Install the plug(s) in any grommet that will not be used and lubricate all four sides of the grommet with silicone lubricant.

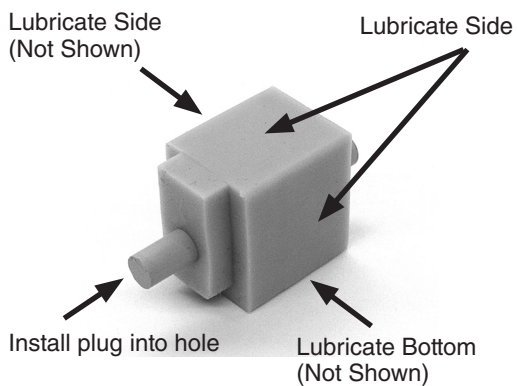

Step #5 Insert the grommet(s) with the plug(s) in any cable port(s) that will not be used.



General Duct Preparation

Step #6 Measure each duct to determine the diameter of the duct and select the proper grommet(s) for your application.

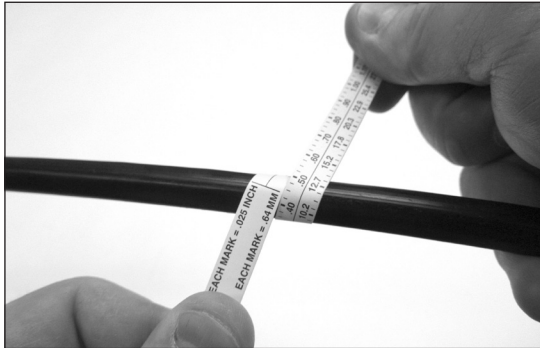

Small Grommets

Small Grommets		Cable Diameter Range
A		SOLID / PLUG
B		.170" - .250" (4.3 - 6.4 mm) ROUND CABLES
C		.250" - .350" (6.4 - 8.9 mm) ROUND CABLES
D		.156" - .170" (4.0 - 4.3 mm) ROUND CABLES
E		.093" - .125" (2.4 - 3.2 mm) ROUND CABLES
F		FLAT DROP CABLES
G		.350" - .420" (8.9 - 10.7 mm) ROUND CABLES

Step #6 (Continued)

Large Grommets

Large Grommet		Cable Diameter Range
A		5 Hole Design 1 Hole - .55" - .60" (14 - 15 mm) 4 Holes - .275" (7 mm)
B		7 Hole Design 1 Hole - .55" - .60" (14 - 15 mm) 6 Holes - .197" (5 mm)

Step #7 Insert each duct in the appropriate grommet.

Small Grommets

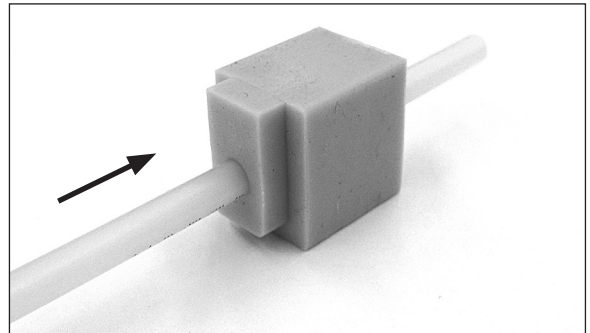

Large Grommets

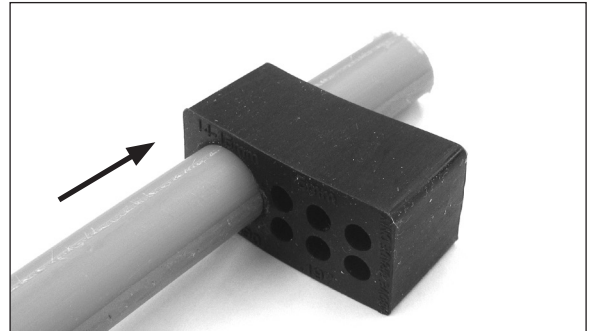

Step #8 If the duct is a Figure 8 style duct or has a tracer wire, remove the ground wire or tracer wire from the portion of the duct that will be positioned in the grommet and insert the duct into the grommet.

Duct with Tracer Wire

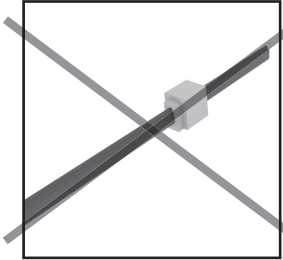

NOT CORRECT INSTALLATION

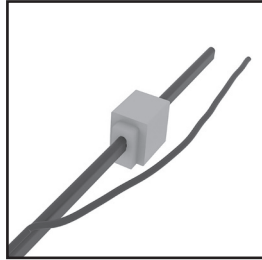

CORRECT INSTALLATION

Figure 8 Style Cable

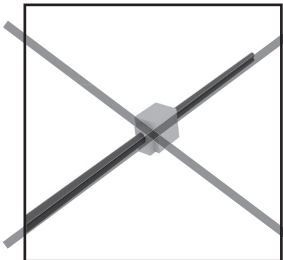

NOT CORRECT INSTALLATION

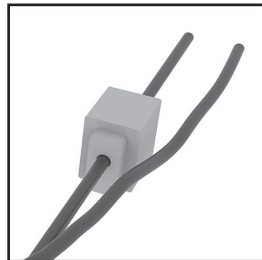

CORRECT INSTALLATION

Step #9 Expose the fibers a minimum of 43" (109 cm) past the duct opening.

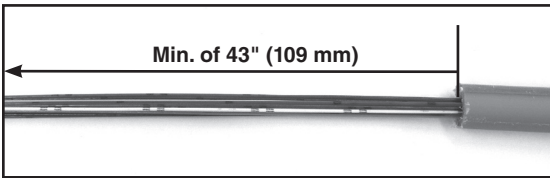

Step #10 Adjust each grommet as shown below.

Small Grommets

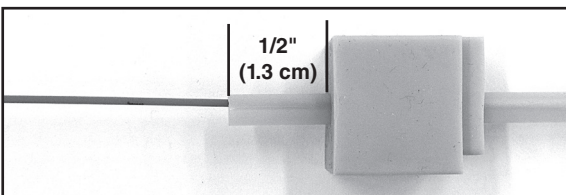

Step #10 Continued

Large Grommets

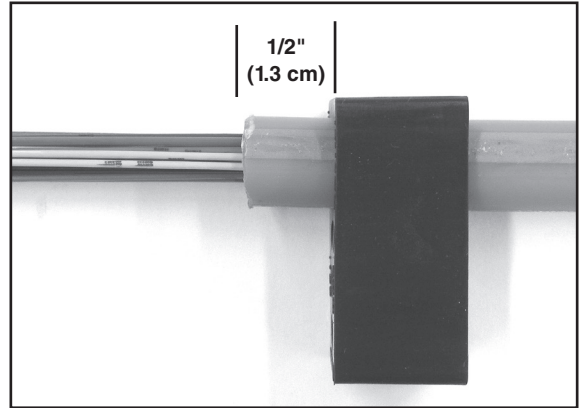

Preparation and Installation of Small and Large Grommets

Step #11 Apply a light coating of lubricant to all outer surfaces of the grommet.

Small Grommets

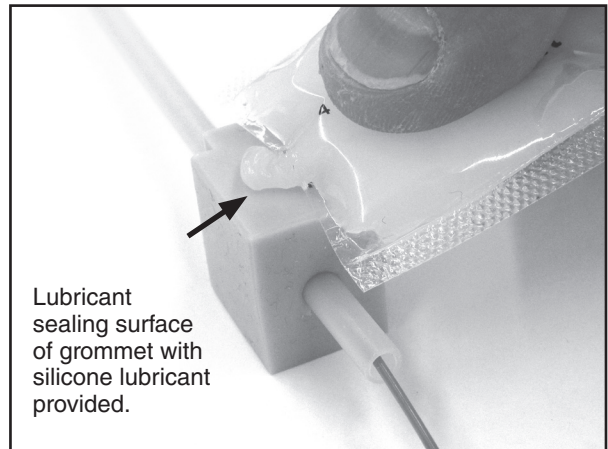

Lubricant sealing surface of grommet with silicone lubricant provided.

Large Grommets

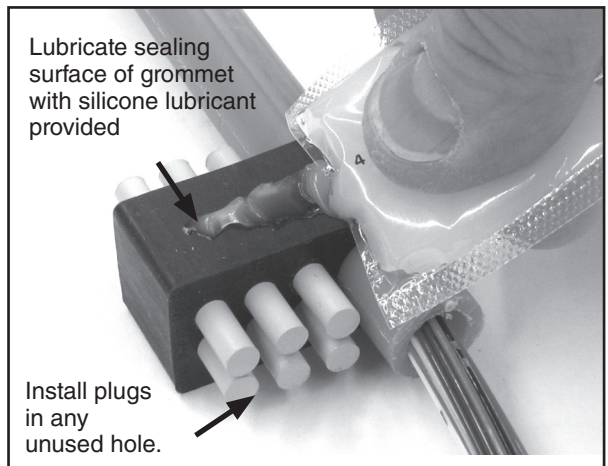

Lubricate sealing surface of grommet with silicone lubricant provided

Install plugs in any unused hole.

Step #12 Install the grommets into the grommet pocket.

Small Grommets

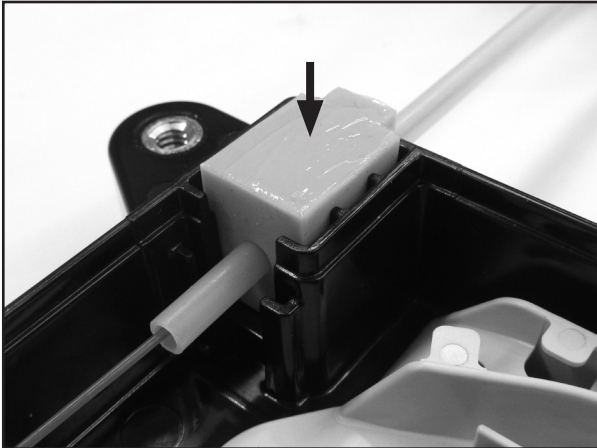

Large Grommets

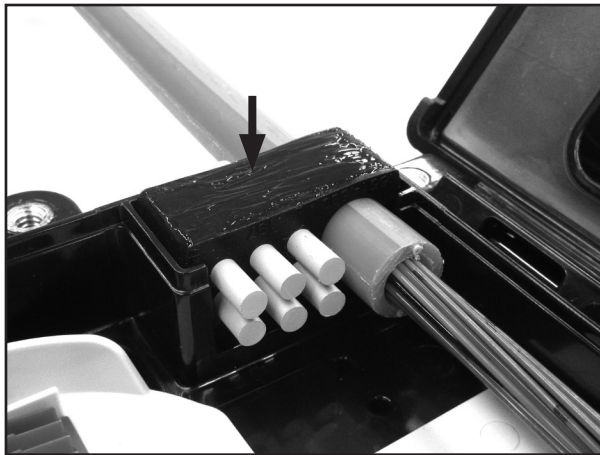

Routing Fibers

Step #13 Route expressed fibers as shown below.

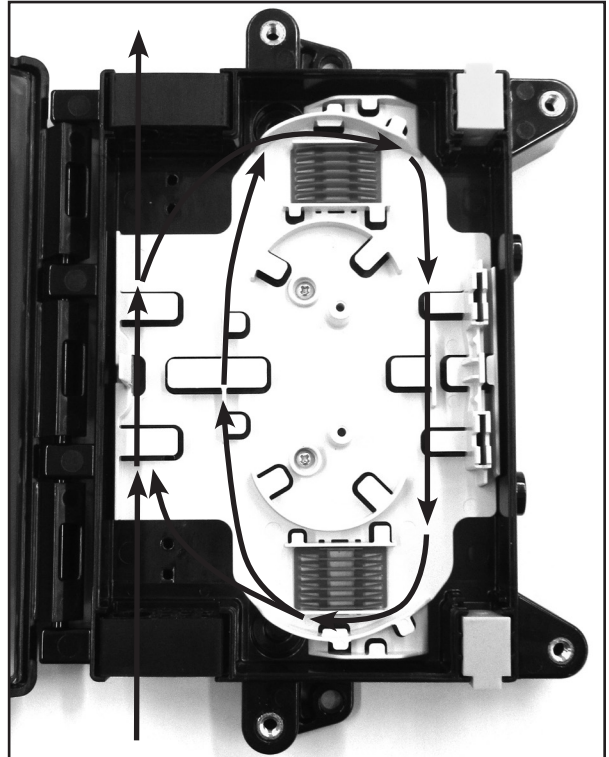

Step #14 Route and splice fibers per your accepted company practice.

Cross-Connect Applications

Step #15 Route incoming and outgoing fibers to the side of the splice block facing the two cable ports, per your accepted company practice.

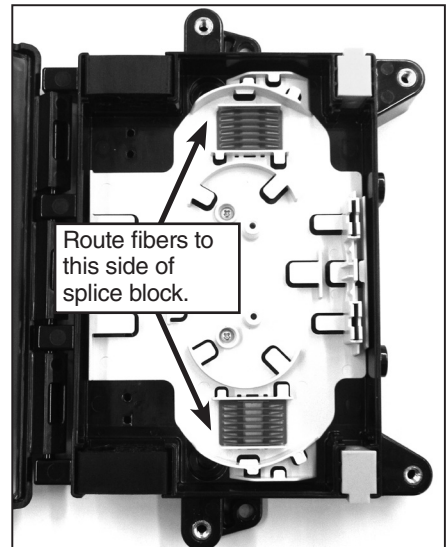

Cross-Connect Applications

Step #16 Install hinge of bulkhead tray into fiber organizer as shown.

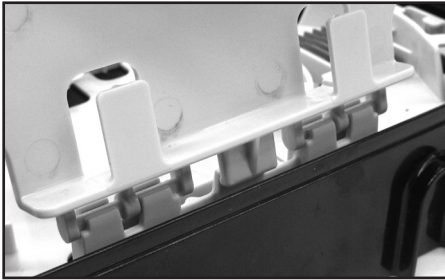
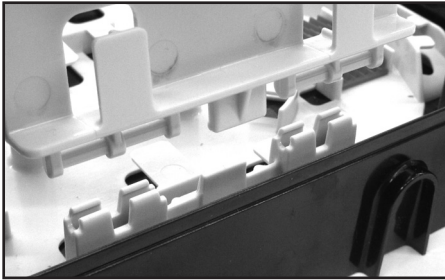

Step #17 Store the fiber pick on the bottom side of the bulkhead tray.

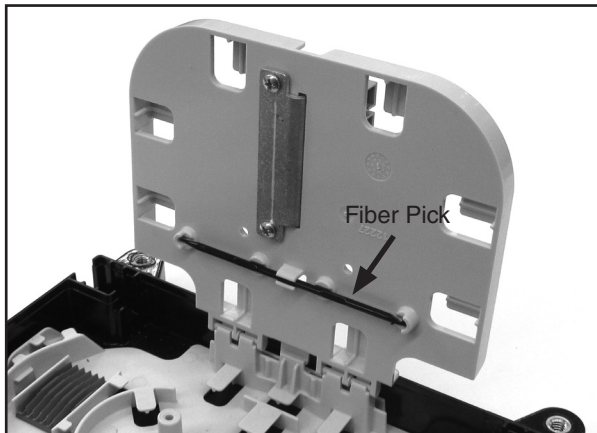

Step #18 Latch the bulkhead tray into place.

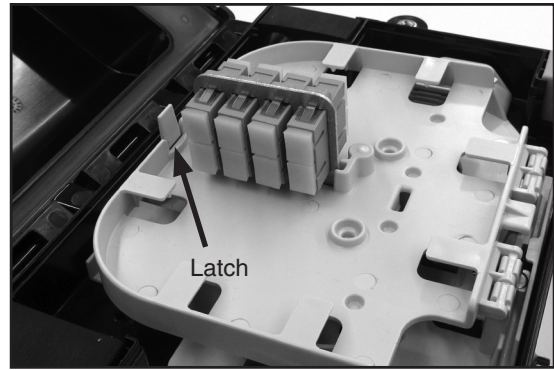

Step #19 Insert the pigtail connectors into the adapters of the bulkhead tray.

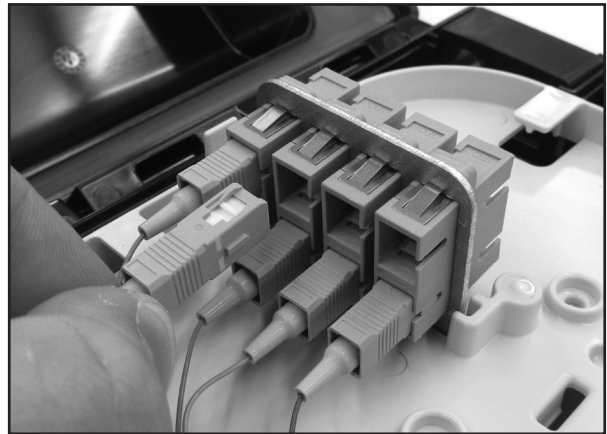

Step #20a Route the pigtails for incoming fibers.

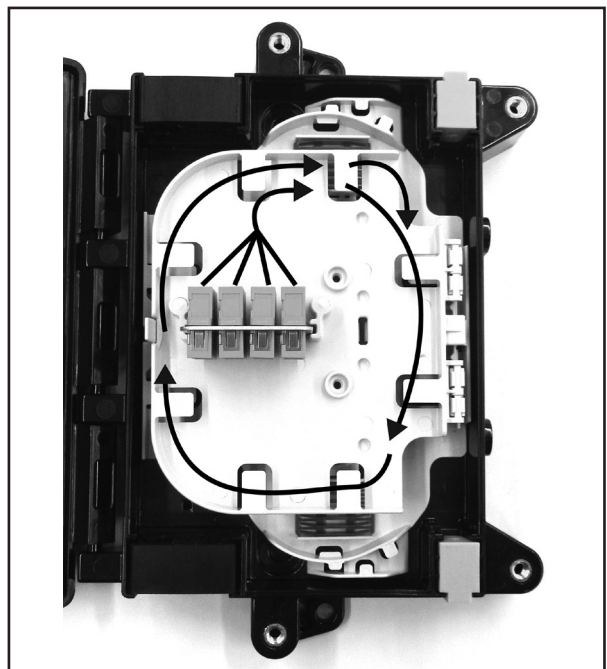

Step #20b Route the pigtails for incoming fibers.

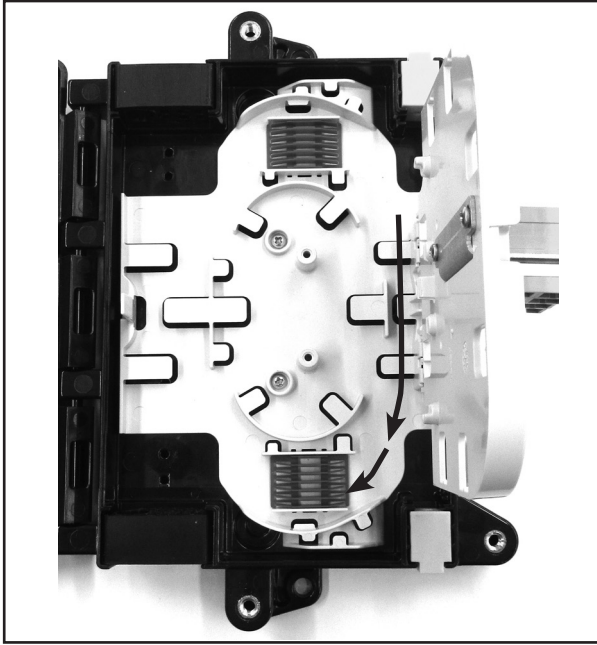

Step #21b Route the pigtails for incoming fibers.

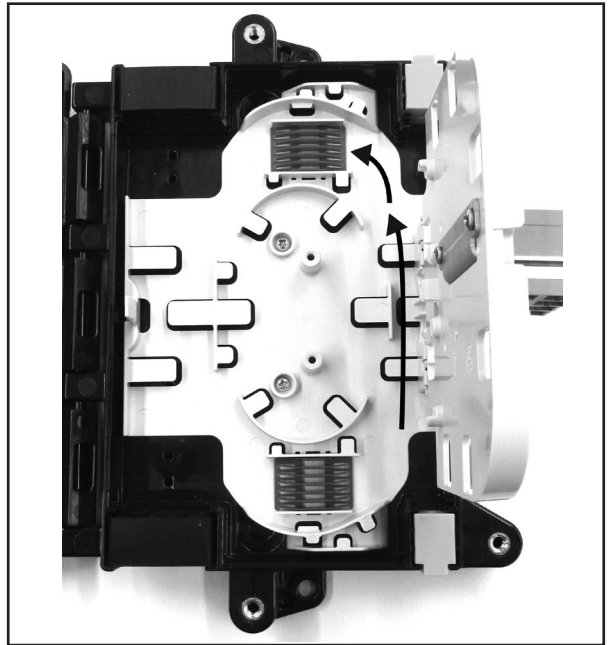

Step #21a Route the pigtails for outgoing fibers.

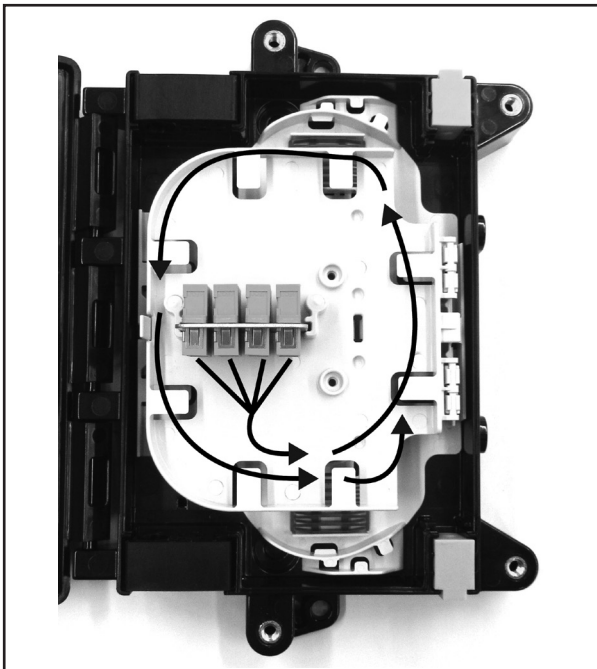

Step #22 Splice the matching fibers and the pigtail fibers (ex.: incoming fiber 1 to incoming pigtail fiber 1) per your accepted company practice.

Duct Transition Applications

Step #23 Route the fibers from the incoming duct to the outgoing duct(s).

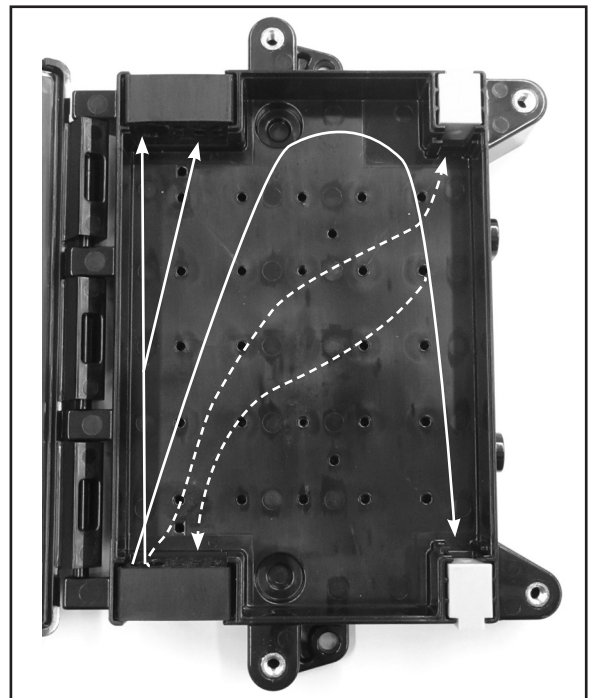

Cover Installation

Step #24 Close the cover and secure it to the base by hand tightening the 4 hex head bolts.

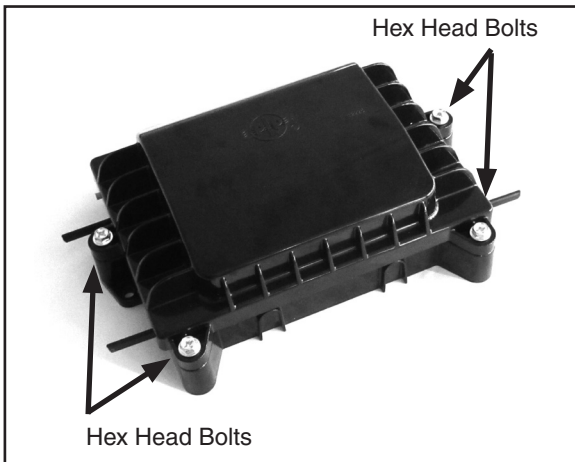

NOTE: Tighten bolts evenly by hand. DO NOT USE POWER TOOLS TO INSTALL THE COVER.

NOTE: When using a can wrench or a nut driver, the installed torque is 35 to 40 in. lbs.

Mounting Options

Step #25 Pole/ Wall Mounting as shown below.

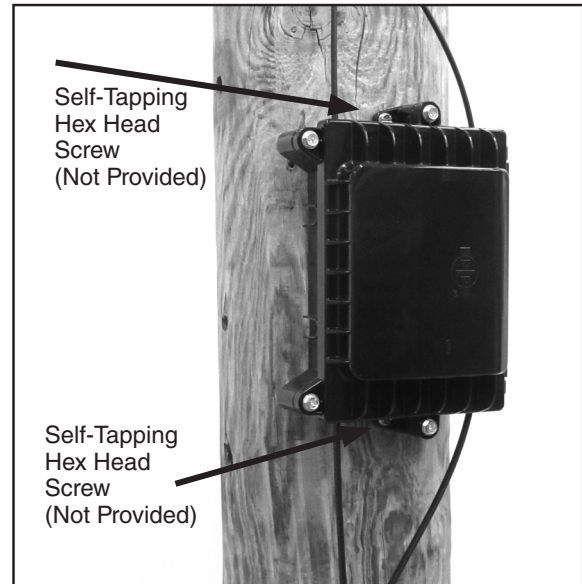

SAFETY CONSIDERATIONS

This application procedure is not intended to supersede any company construction or safety standards. This procedure is offered only to illustrate safe application for the individual. **FAILURE TO FOLLOW THESE PROCEDURES MAY RESULT IN PERSONAL INJURY OR DEATH.**

Do not modify this product under any circumstances.

This product is intended for use by trained technicians only. **This product should not be used by anyone who is not familiar with, and not trained to use it.**

When working in the area of energized lines, extra care should be taken to prevent accidental electrical contact.

For proper performance and personal safety, be sure to select the proper size PREFORMED™ product before application.

PREFORMED products are precision devices. To insure proper performance, they should be stored in cartons under cover and handled carefully.



PREFORMED LINE PRODUCTS

P.O. Box 91129, Cleveland, Ohio 44101 • 440.461.5200 • www.preformed.com • e-mail: inquiries@preformed.com

SP3270-1