

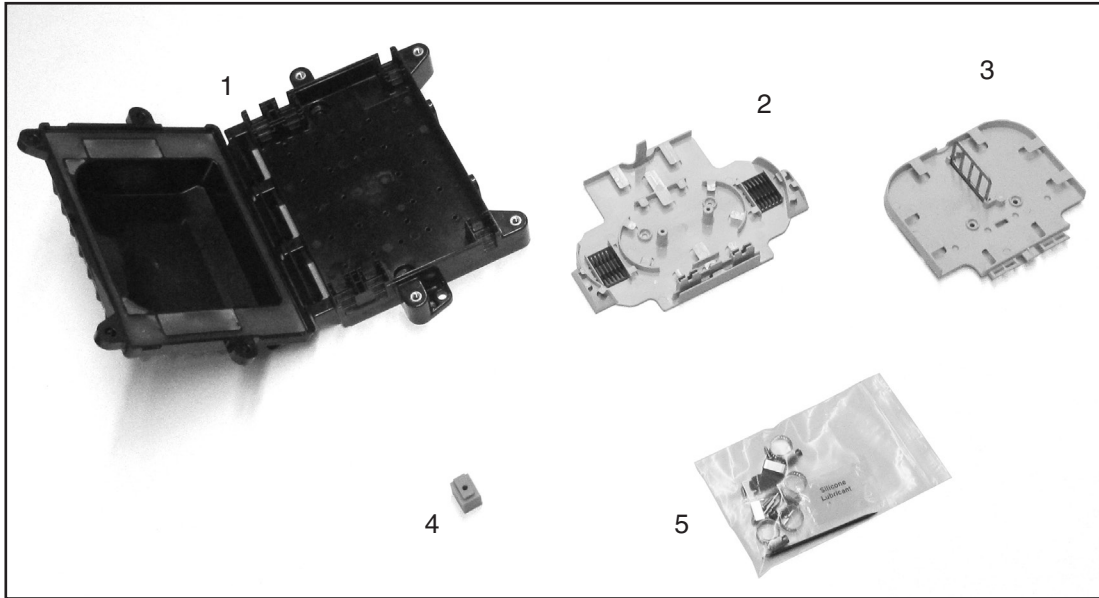

## COYOTE® DTC6 (Drop Termination Closure)

Be sure to read and completely understand this procedure before applying product. Be sure to select the proper PREFORMED™ product before application.



**NOMENCLATURE**

- 1. Base with Cover (1)
- 2. Splice Organizer (1)
- 3. Bulkhead Tray (with Splice and Adapters Organizer) (1)

- 4. Small Grommets (6)
- 5. Small Parts Bag (1)

**TOOLS REQUIRED**

- 3/8" & 7/16" socket or can wrench
- Fiber optic cable opening tools
- 1/4" Nut driver or screwdriver
- Phillips Head Screwdriver
- Snips

COYOTE® DTC 4/6 Mounting Bracket Kits		
Catalog Number	Description	Kit Image
8004109	COYOTE DTC 4/6 Pole/Wall Mount Bracket Kit	
8004110	COYOTE DTC 4/6 Cable Storage Bracket Kit	
8004111	COYOTE DTC 4/6 Aerial Mounting Bracket Kit – Strand Applications	
8004112	COYOTE DTC 4/6 Aerial Mounting Bracket Kit – ADSS Applications	

## General Base Preparation

**Step #1** Install the fiber organizer into the base with the self-tapping screws provided.



**Step #2** Determine the cable entry locations for butt applications as shown below.

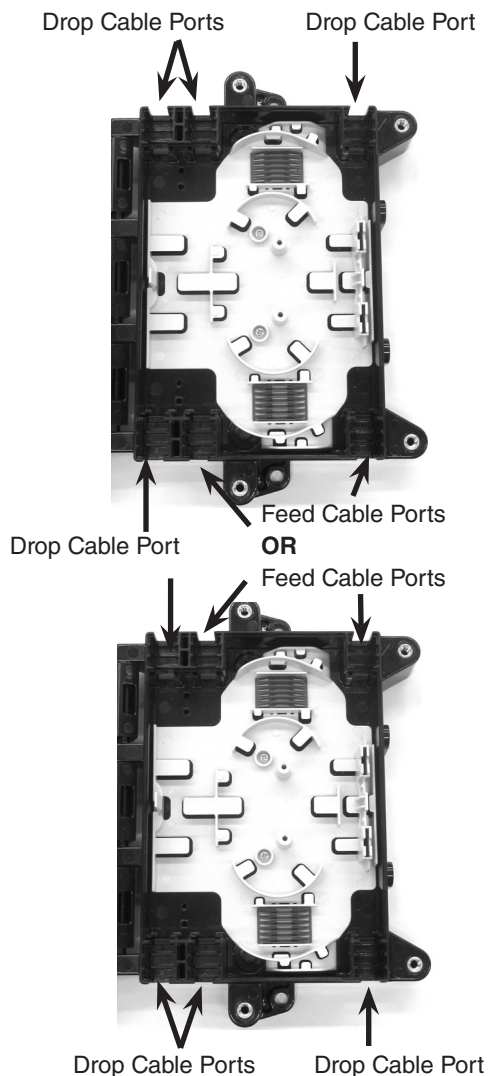

**Step #3** Determine the cable entry locations for in-line applications as shown below.

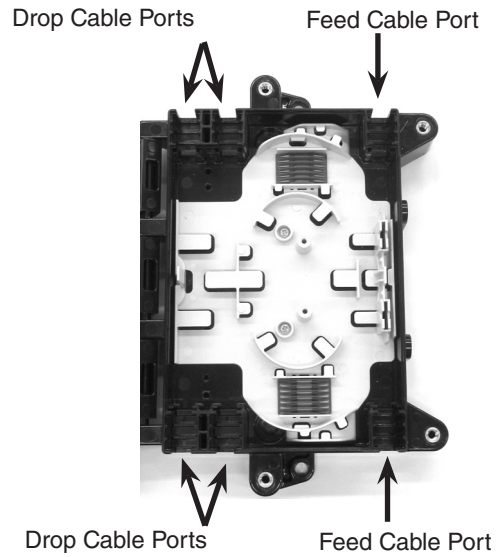

**Step #4** Install the plug(s) in any grommet that will not be used and lubricate all four sides of the grommet with silicone lubricant.

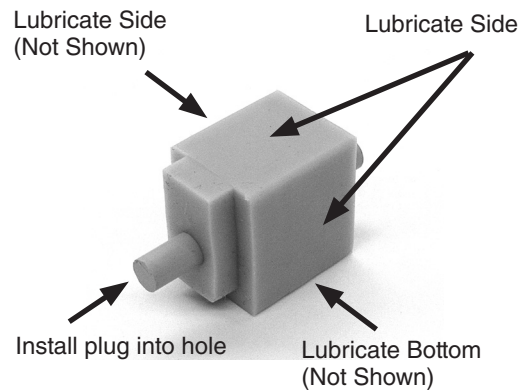

**Step #5** Insert the grommet(s) with the plug(s) in any cable port(s) that will not be used.

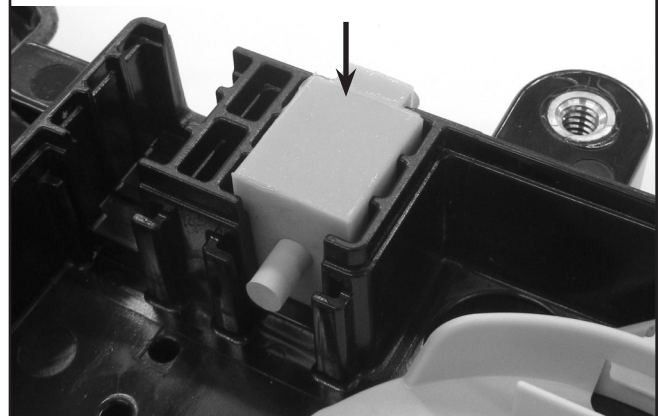

## General Base Preparation

**Step #6** Measure each cable to determine the diameter of the cable and select the proper grommet(s) for your application.

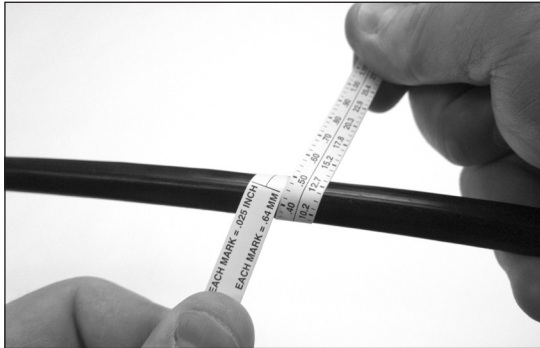

**NOTE:** The lines on each grommet represent the slit locations for cables expressing fiber or pre-connectorized drop cables.

	Small Grommets	Cable Diameter Range
A		SOLID / PLUG
B		.170" - .250" (4.3 - 6.4 mm) ROUND CABLES
C		.250" - .350" (6.4 - 8.9 mm) ROUND CABLES
D		.156" - .170" (4.0 - 4.3 mm) ROUND CABLES
E		.093" - .125" (2.4 - 3.2 mm) ROUND CABLES
F		FLAT DROP CABLES
G		.350" - .420" (8.9 - 10.7 mm) ROUND CABLES

**Step #7** Insert each cut cable in the appropriate grommet. If the cable is expressing fiber, slit the grommets as shown below, before installing the grommets over the cable. (See Step 6 for slit locations on each grommet).

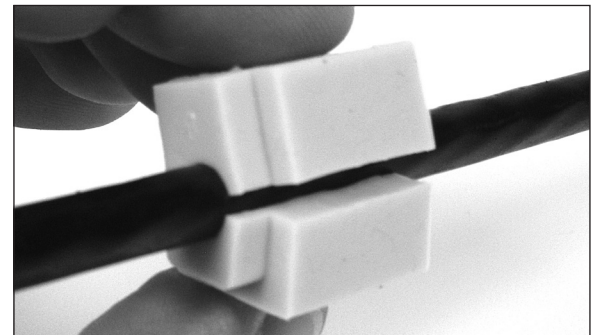
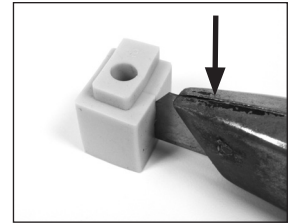
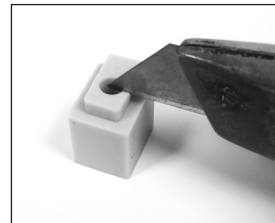
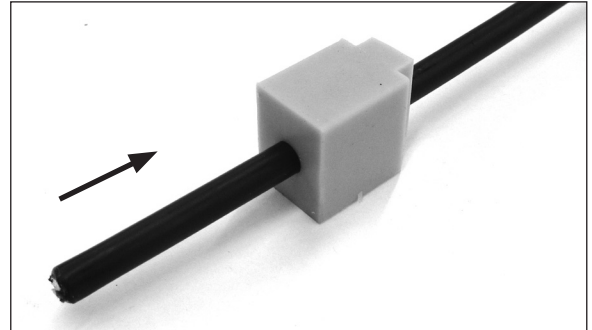

**Step #8** If the cable is a Figure 8 style cable or has a tracer wire, remove the ground wire or tracer wire from the portion of the cable that will be positioned in the grommet and insert the cable into the grommet.

**Cable with Tracer Wire**

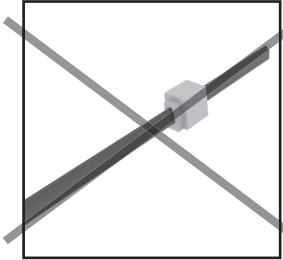

NOT CORRECT INSTALLATION

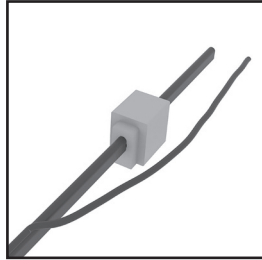

CORRECT INSTALLATION

**Figure 8 Style Cable**

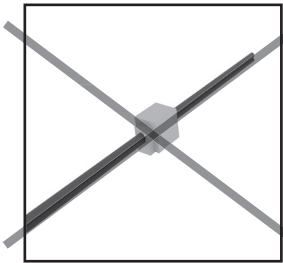

NOT CORRECT INSTALLATION

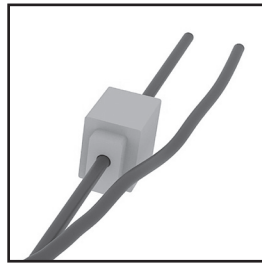

CORRECT INSTALLATION

**Step #9** Measure, mark and remove the cable sheath for cut cable applications, as shown below.

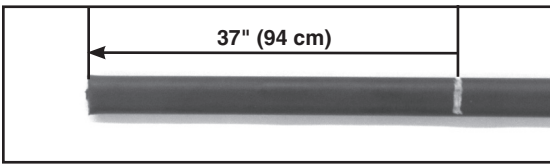

**Step #10** Measure, mark and remove the cable sheath for expressed fiber applications, as shown below.

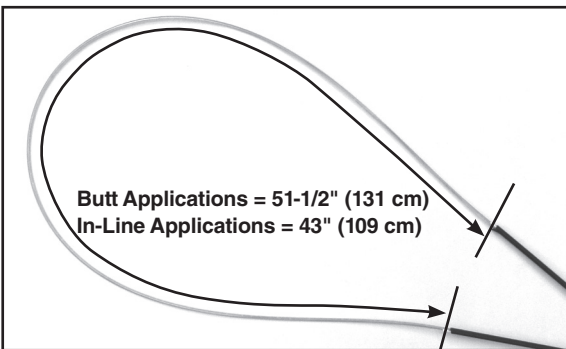

**Step #11** Trim the strength members flush with the sheath opening.

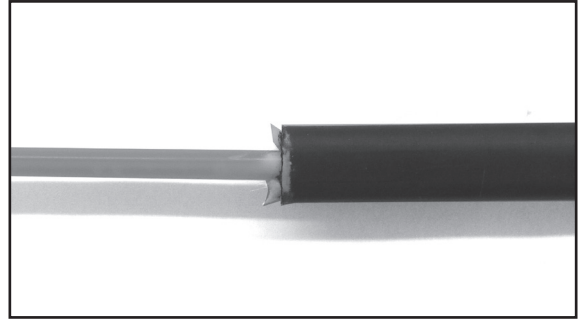

**Step #12** Mark and remove the buffer tube 1/8" (.32 cm) away from the sheath opening.

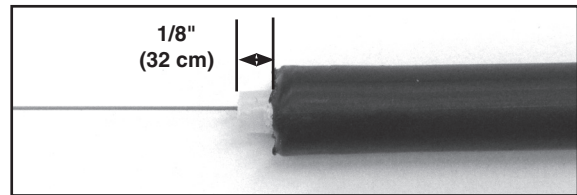

**Step #13** Adjust each grommet as shown below.

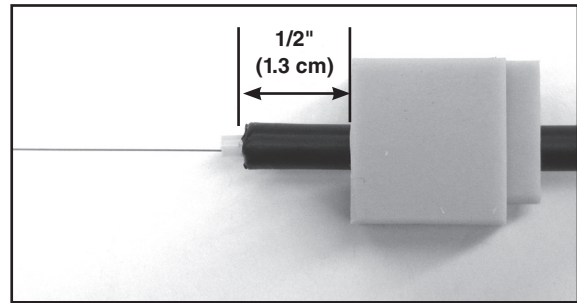

## Preparation and Installation of Round Drop Cable

**Step #14** If the cable contains Kevlar®, braid the Kevlar.

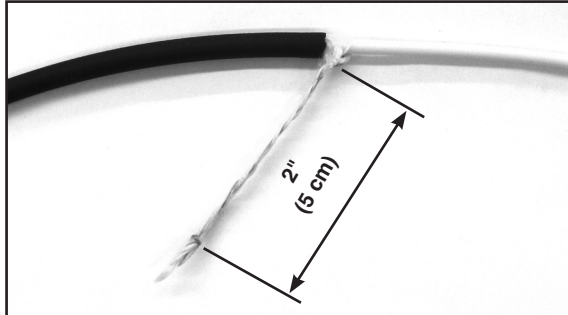

**NOTE:** If the cable contains Kevlar but is the feed cable, then follow Steps 17 and 18.

**Step #15** Lubricate the grommet (Step #4) and place it into the pocket of the base.

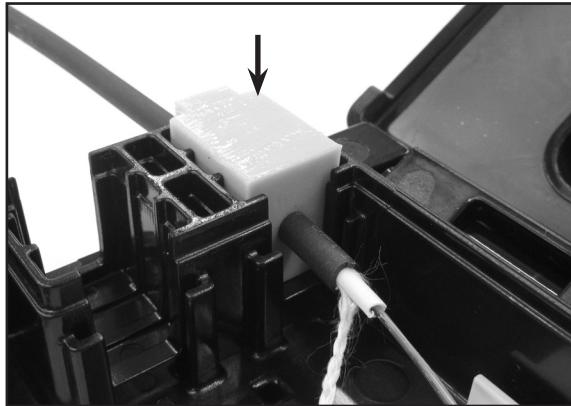

**Step #16** For drop cables with Kevlar, place a screw in the hole next to the grommet pocket. Wrap the braided Kevlar around the screw and tighten the screw.

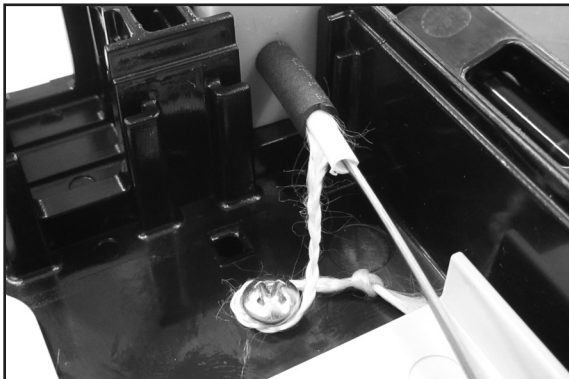

**Step #17** If the cable does not contain Kevlar or contains Kevlar but is the feed cable, align the end of the hose clamp clip with the cable sheath opening and secure it with the micro hose clamp. Make sure that the head of the hose clamp is seated on top of the cable as shown below.

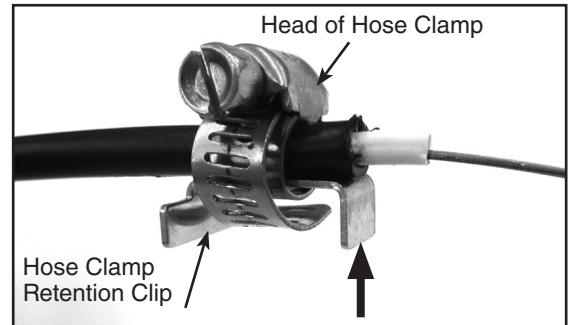

**Step #18** Insert the back of the hose clamp clip in the retention clip slot of the base while inserting the grommet into the grommet pocket. Make sure that the grommet has been lubricated before inserting it into the grommet pocket (Step #4).

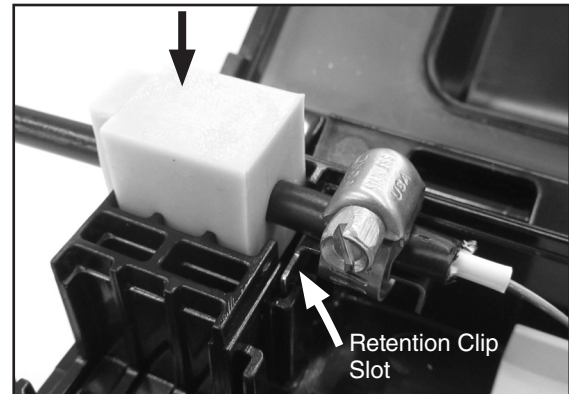

## Preparation for Figure 8 Drop Cable or Drop Cable with Tracer Wire

**Step #19** Peel back the tracer wire or ground wire from the cable.

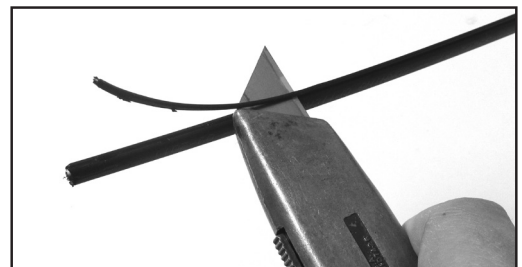

**Step #20** Shave the rough edges of the cable where the tracer wire or ground wire was removed in the area where the grommet will be located.

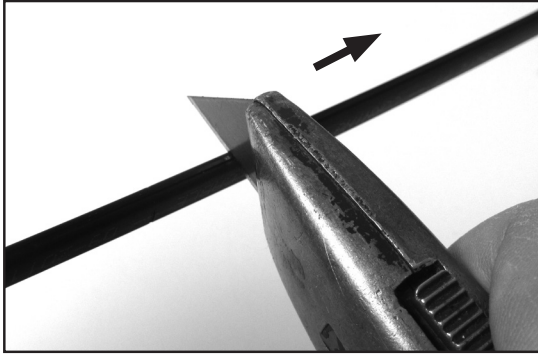

**Step #21** Insert the cable through the grommet while leaving the tracer wire or ground wire to the side.

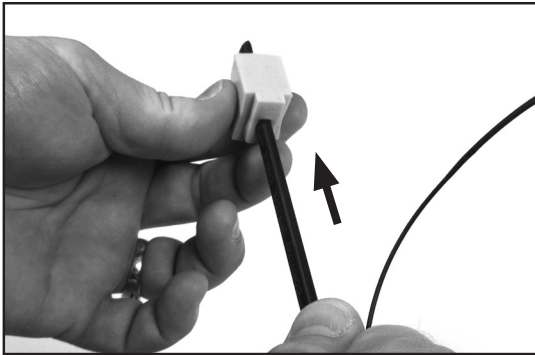

**Step #22** Install the cable into the closure while leaving the tracer wire or ground wire on the outside of the closure.

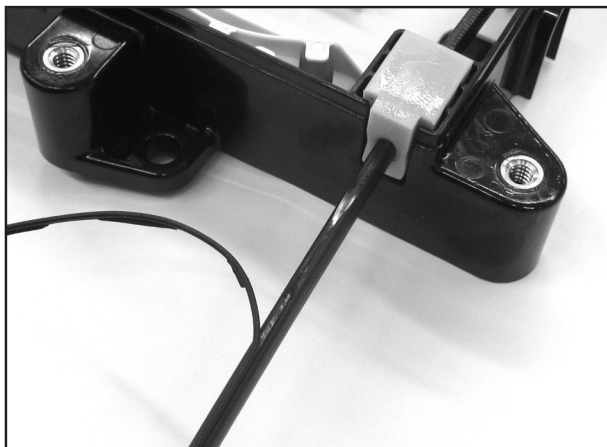

**Step #23** If the cables have tracer wires, connect the 2 tracer wires using a Scotchlok™ Connector (not included).

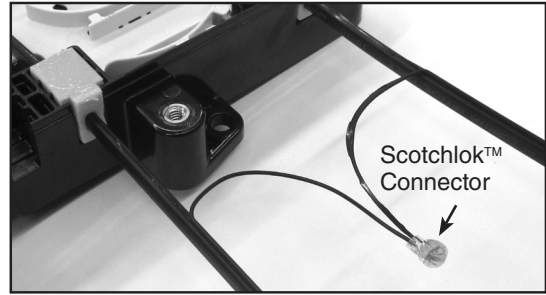

### Routing for Butt Splice Applications

**Step #24** Route expressed fibers as shown below.

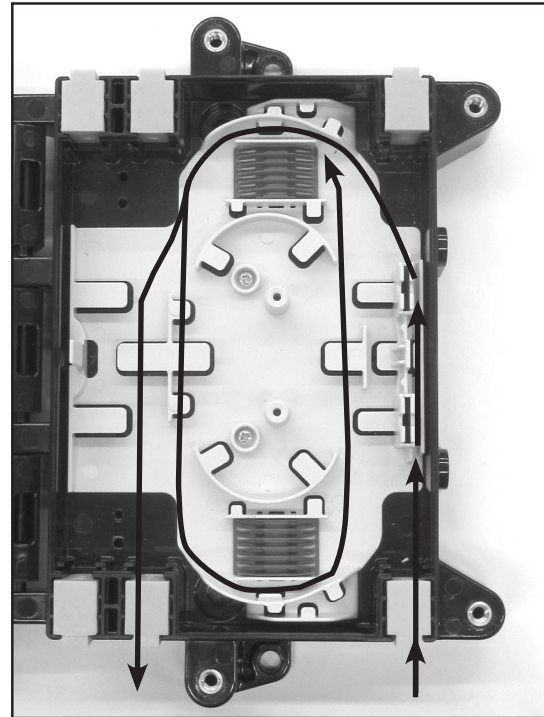

## Routing for In-Line Splice Applications

**Step #25** Route expressed fibers as shown below.

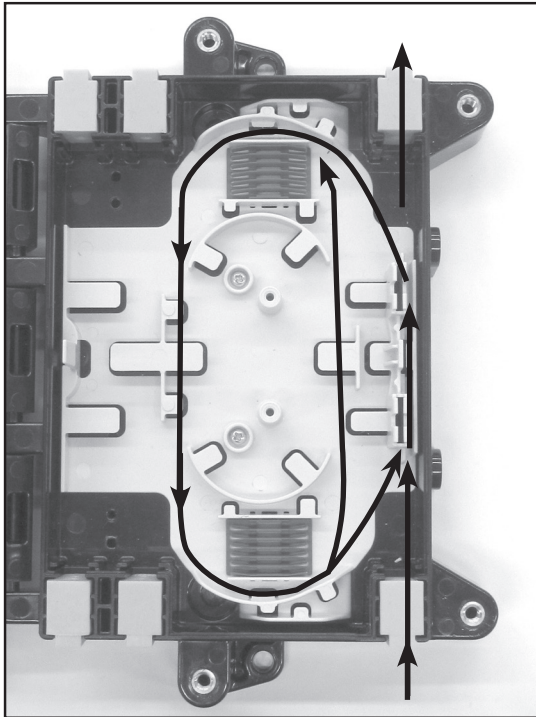

**Step #26** Route and splice fibers per your accepted company practice.

## Cross-Connect Applications

**Step #27** Route the incoming and the outgoing fibers to the side of the splice block facing the two cable ports per your accepted company practice.

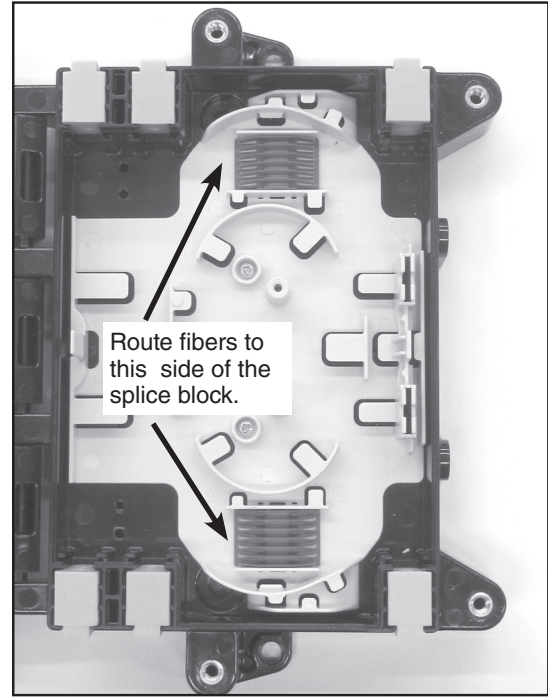

**Step #28** Install the hinge of the bulkhead tray into the fiber organizer as shown below.

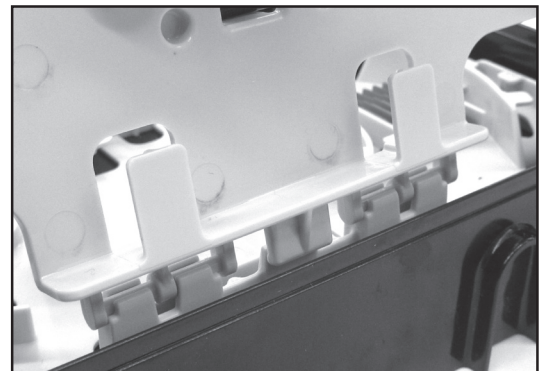
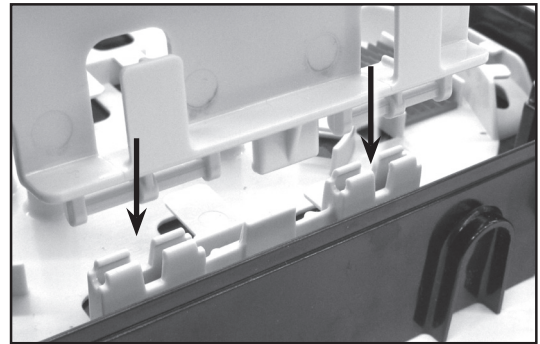

**Step #29** Store the fiber pick on the bottom side of the bulkhead tray.

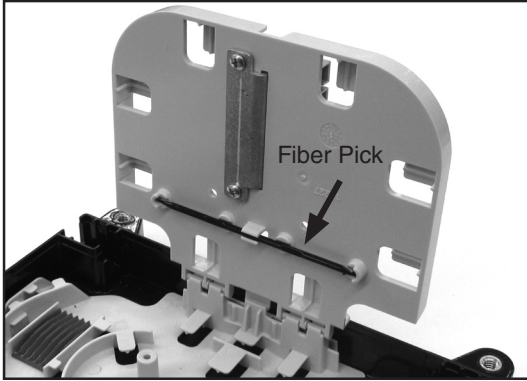

**Step #30** Latch the bulkhead tray into place.

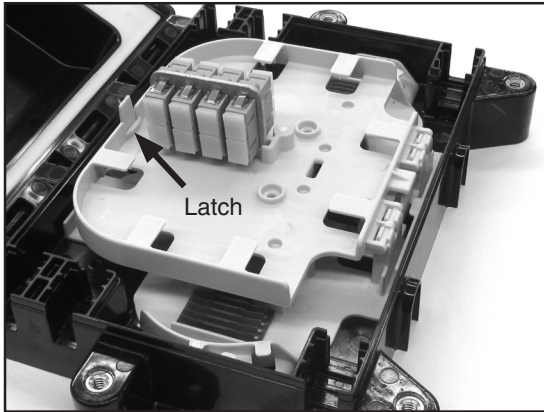

**Step #31** Insert the pigtail connectors into the adapters of the bulkhead tray.

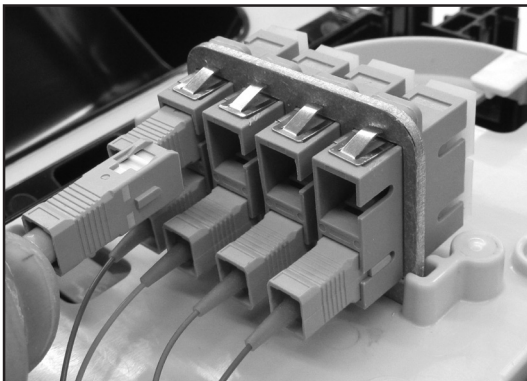

**Step #32a** Route pigtails for incoming fibers as shown below.

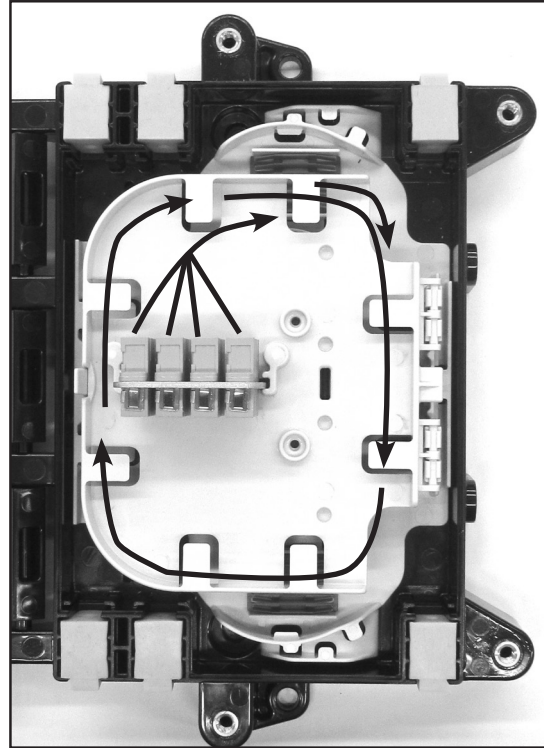

**Step #32b** Route the pigtails for incoming fibers as shown below.

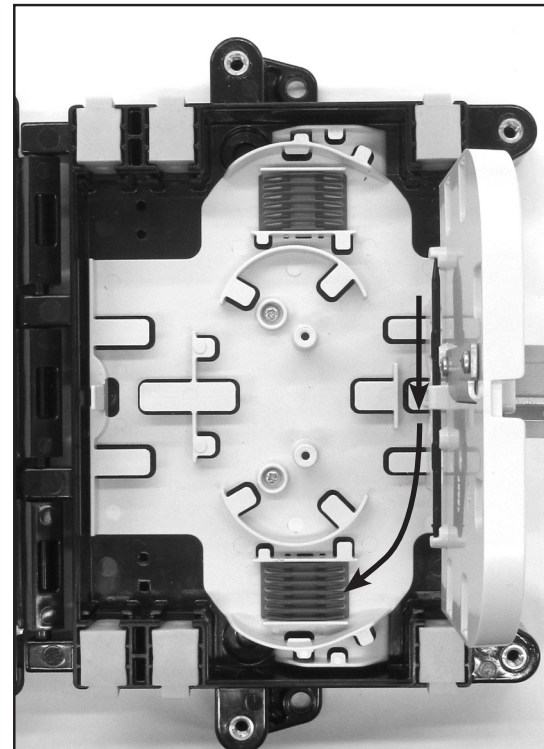



**Step #33a** Route the pigtails for outgoing fibers as shown below.

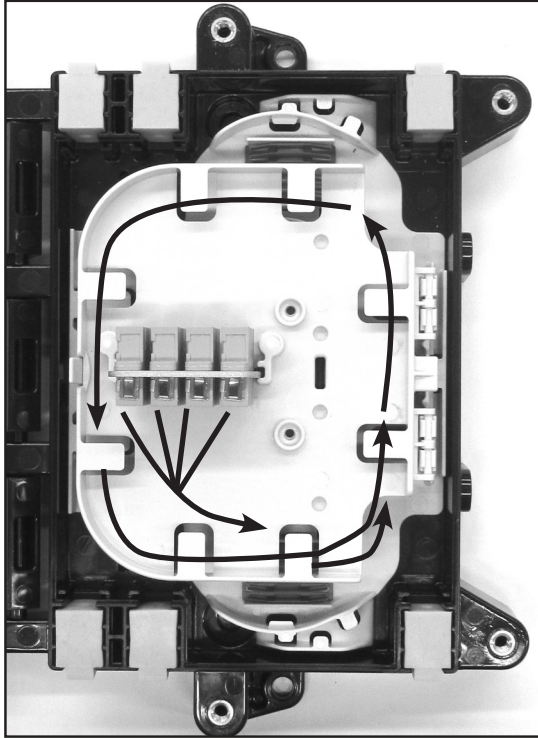

**Step #33b** Route the pigtails for incoming fibers.

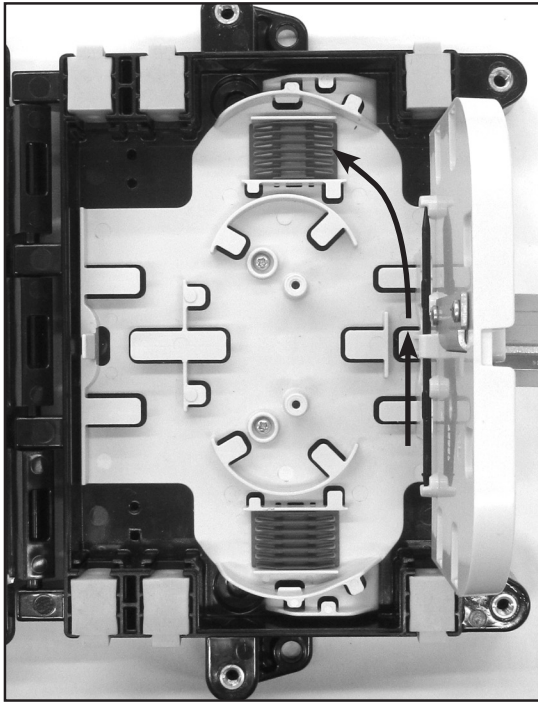

**Step #34** Splice the matching fibers and the pigtail fibers (ex.: incoming fiber 1 to incoming pigtail fiber 1) per your accepted company practice.

## Cover Installations

**Step #35** Close the cover and secure it to the base by hand tightening the 4 hex head bolts.

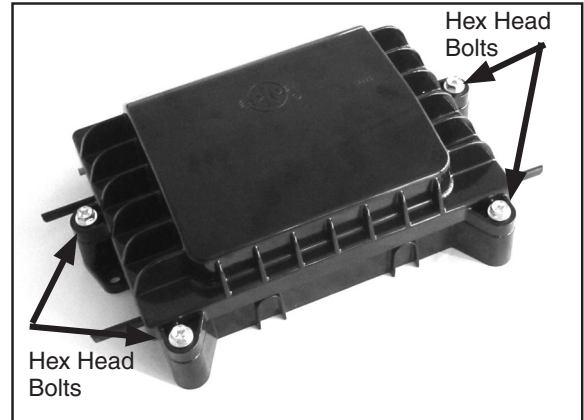

**NOTE:** Tighten bolts evenly by hand. **DO NOT USE POWER TOOLS TO INSTALL THE COVER.**

**NOTE:** When using a can wrench or a nut driver, the installed torque is 35 to 40 in. lbs.

## Mounting Options

**Step #36** Pole/ Wall Mounting shown below.

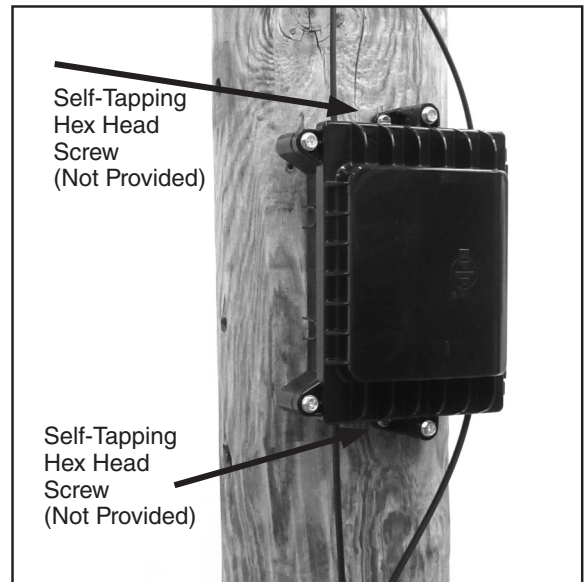





## SAFETY CONSIDERATIONS

This application procedure is not intended to supersede any company construction or safety standards. This procedure is offered only to illustrate safe application for the individual. **FAILURE TO FOLLOW THESE PROCEDURES MAY RESULT IN PERSONAL INJURY OR DEATH.**

**Do not modify this product under any circumstances.**

This product is intended for use by trained technicians only. **This product should not be used by anyone who is not familiar with, and not trained to use it.**

When working in the area of energized lines, extra care should be taken to prevent accidental electrical contact.

For proper performance and personal safety, be sure to select the proper size PREFORMED™ product before application.

PREFORMED products are precision devices. To insure proper performance, they should be stored in cartons under cover and handled carefully.



# PREFORMED LINE PRODUCTS

P.O. Box 91129, Cleveland, Ohio 44101 • 440.461.5200 • [www.preformed.com](http://www.preformed.com) • e-mail: [inquiries@preformed.com](mailto:inquiries@preformed.com)  
SP3271-1