



COYOTE® DTC8 for Splicing and Storing with Cross-Connect Capability

Be sure to read and completely understand this procedure before applying product. Be sure to select the proper PREFORMED™ product before application.



NOMENCLATURE

- | | |
|--------------------------------------|-------------------------|
| 1. Base (1) | 7. Bulkhead Tray (1) |
| 2. Cover (1) | 8. Bulkhead (1) |
| 3. Collar (1) | 9. Large Grommet (4) |
| 4. End Plate (1) | 10. Small Grommet (4) |
| 5. Buffer Tube Storage Organizer (1) | 11. Splice Tray (0 - 4) |
| 6. Splice Tray Organizer (1) | 12. Small Parts Bag (1) |

TOOLS REQUIRED

- 3/8" & 7/16" sockets or can wrench
- Fiber optic cable opening tools
- 1/4" Nut driver or screwdriver
- Phillips Head Screwdriver
- Snips

COYOTE® DTC8 Mounting Bracket Kits		
Catalog Number	Description	Kit Image
8004104	COYOTE DTC8 Pole/Wall Mount Bracket Kit	
8004105	COYOTE DTC8 Cable Storage Bracket Kit	
8004108	COYOTE DTC8 Pedestal Mounting Bracket Kit	
8004111	COYOTE DTC 4/6 Aerial Mounting Bracket Kit – Strand Applications	
8004112	COYOTE DTC 4/6 Aerial Mounting Bracket Kit – ADSS Applications	
80812501	Cover Lanyard Kit	

Feed and Branch Cable Preparation

Step #1 Measure each cable to determine the diameter of the cable and select the proper grommet(s) for your application.

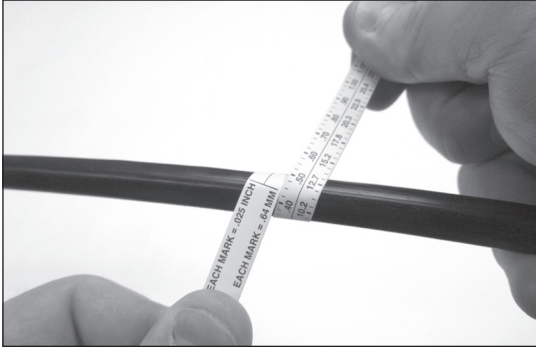

Large Grommet Selection		Cable Diameter Range
A		SOLID / PLUG
B		.170" - .220" (4.3 - 5.6 mm) ROUND CABLES
C		.220" - .270" (5.6 - 6.9 mm) ROUND CABLES
D		.270" - .320" (6.9 - 8.1 mm) ROUND CABLES
E		.320" - .370" (8.1 - 9.4 mm) ROUND CABLES
F		.370" - .420" (9.4 - 10.7 mm) ROUND CABLES
G		.420" - .470" (10.7 - 11.9 mm) ROUND CABLES
H		.470" - .550" (11.9 - 14.0 mm) ROUND CABLES
J		.156" - .170" (4.0 mm - 4.3 mm) ROUND DROP CABLES
K		.093" - .125" (2.4 - 3.2 mm) ROUND DROP CABLES
L		FLAT DROP CABLES ONLY

Step #2 Insert each cut cable in the appropriate grommet. If the cable is expressing fiber, slit the grommets as shown below, before installing the grommets over the cable. (See Step 1 for slit locations on each grommet).

Cut Cables

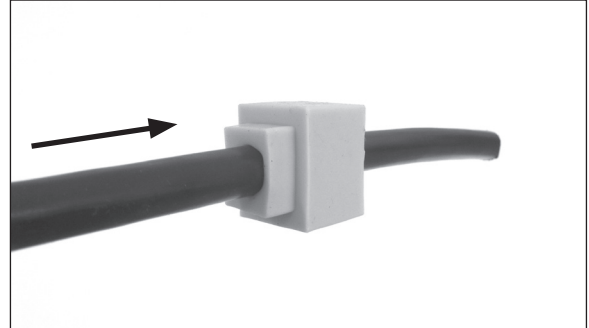

Expressed Cables

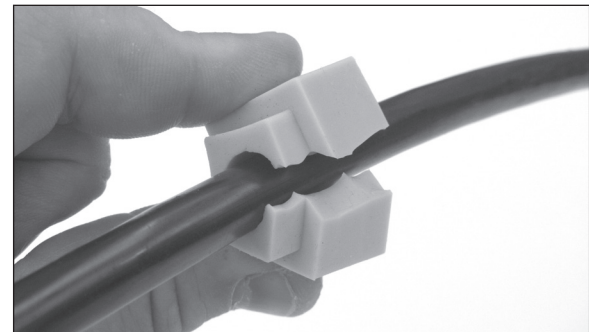
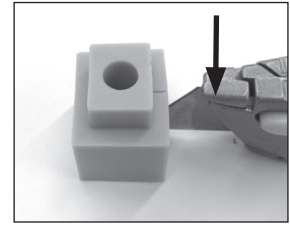
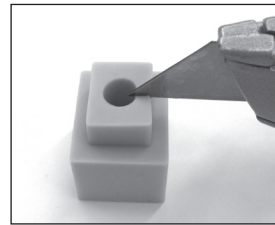

Step #3 If the cable is a Figure 8 style cable or has a tracer wire, remove the ground wire or tracer wire from the portion of the cable that will be positioned in the grommet and insert the cable into the grommet.

Cable with Tracer Wire

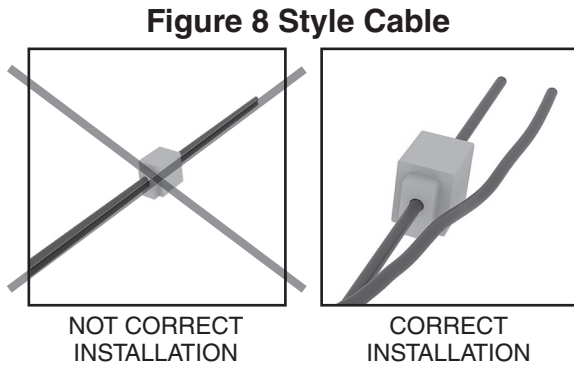
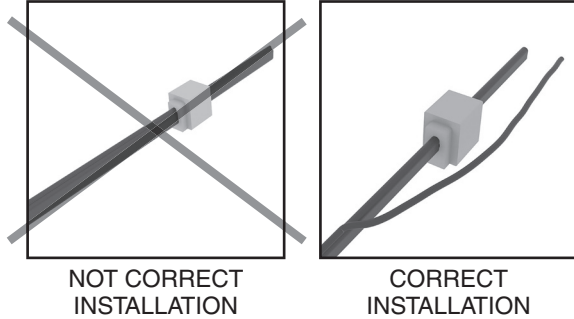

Step #4 Prepare loose tube/buffer tube cables(s) for cut applications.

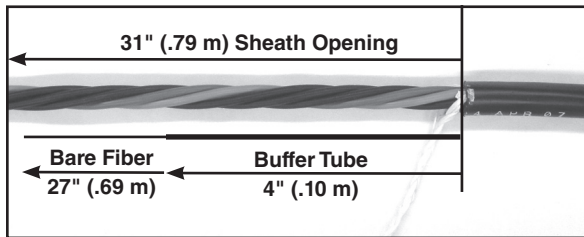

Sheath Opening Breakdown for Feed and Branch Cable	
Buffer Tube Length	4" (.10 m)
Bare Fiber Length	27" (.69 m)
Total Sheath Opening	31" (.79 m)

PLP Tip: Leave about 5" (13 cm) of strength member to trim later.

Cable Sheath Opening for Applications where Fiber is Dedicated to the Splice Point

Step #5a Prepare loose tube/buffer tube or cable(s) for mid sheath applications (Express/Balloon/Ring Cut).

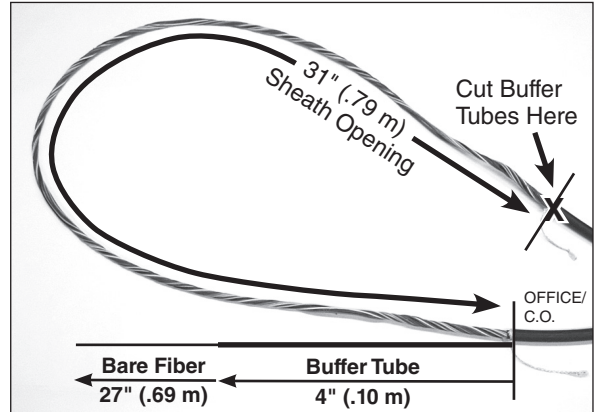

For Applications Where Fiber is Dedicated to the Splice Point	
Buffer Tube Length	4" (.10 m)
Bare Fiber Length	27" (.69 m)
Total Sheath Opening	31" (.79 m)
Fiber/Buffer Tube Cut Location	X (see image above)

PLP Tip: Leave about 5" (13 cm) of strength member to trim later.

Step #5b Prepare loose tube/buffer tube or cable(s) for mid sheath applications (Express/Balloon/Ring Cut).

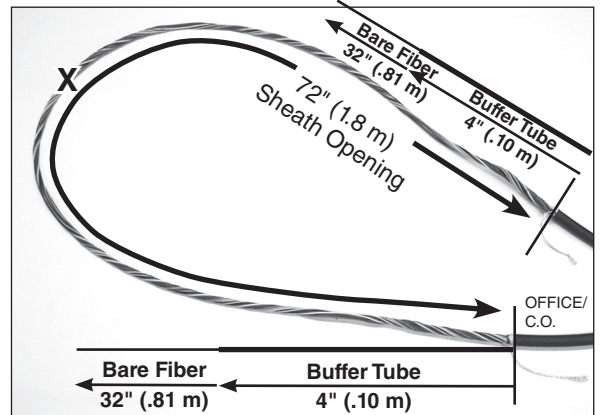

For Applications Where Fiber is NOT Dedicated to the Splice Point	
Buffer Tube Length per Side of Cut	4" (.10 m)
Bare Fiber Length per Side of Cut	32" (.81 m)
Total Length per Side of Cut	36" (.91 m)
Total Sheath Opening	72" (1.8 m)
Fiber/Buffer Tube Cut Location	X (see image above)

PLP Tip: Leave about 5" (13 cm) of strength member to trim later.

Step #6 If the cable contains Kevlar®, braid roughly 3" (7.2 cm) of the Kevlar.

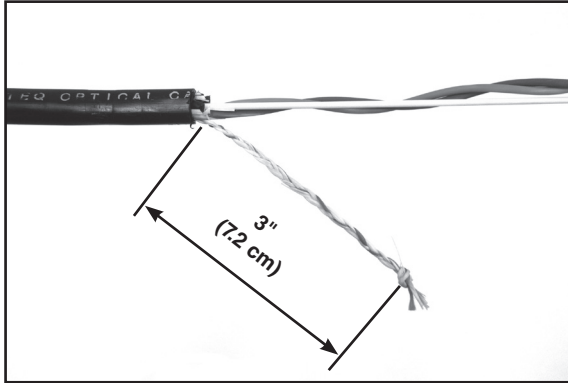

Step #7 Trim the cable strength member 1.5" (3.8 cm) away from the cable sheath opening.

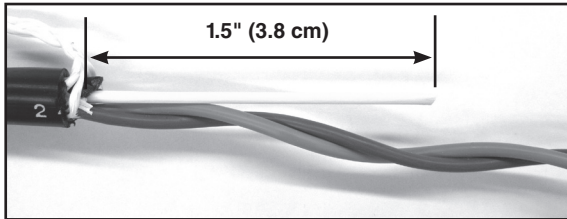

Step #8 Insert the strength member through the terminal and position the terminal half way on the strength member. Secure the terminal on the strength member by tightening the set screw with the allen wrench provided.

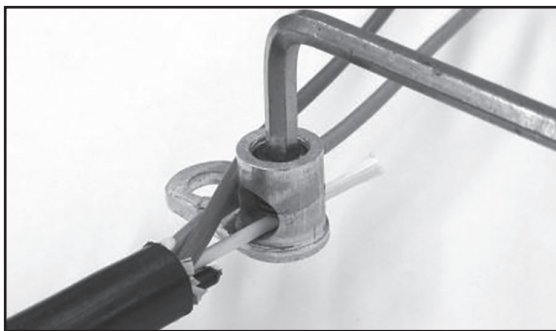

Step #9 Position the grommets 3/4" (1.9 cm) away from the cable sheath opening.

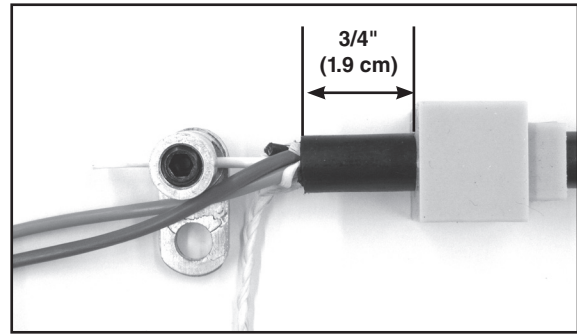

Base Preparation & Storage Organizer Installation

Step #10 Install the posts in the base of the closure as shown.

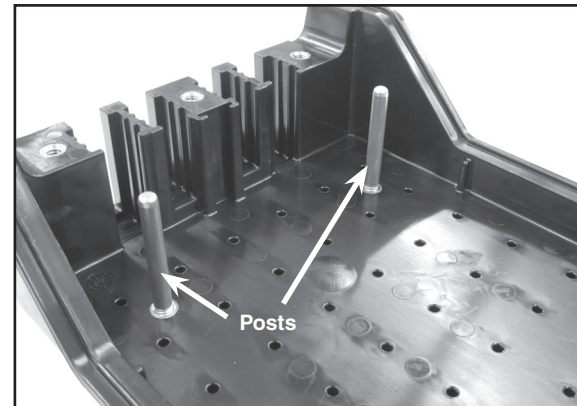

Step #11 Secure the storage organizer to the base with the self-tapping screws provided.

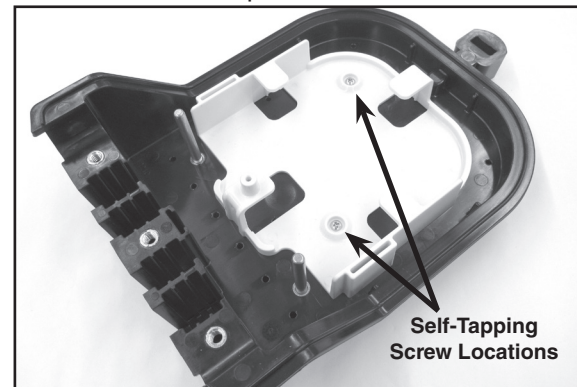

Feed and Branch Cable Preparation

Step #12 Lubricate all four outer surfaces of each grommet. Once the lubricant has been applied, smear it to provide a light coating on each surface.

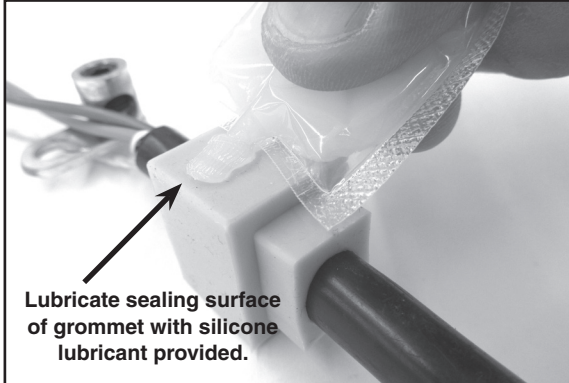

IMPORTANT NOTE:

The large "L" grommet can not be used in the bottom outer two positions when it is slit

Unslit "L" Grommets

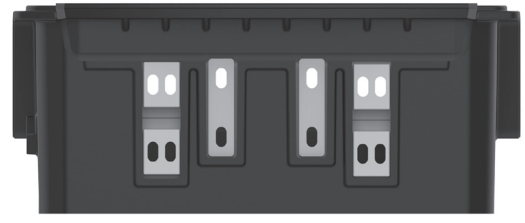

Slit "L" Grommets

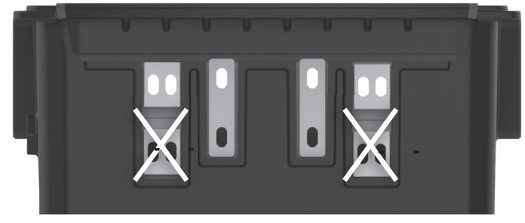

Step #13 Install the terminals on the posts while inserting the grommets in the outside grommet pockets of the closure. Make sure the feed cable is installed first before installing the branch cable.

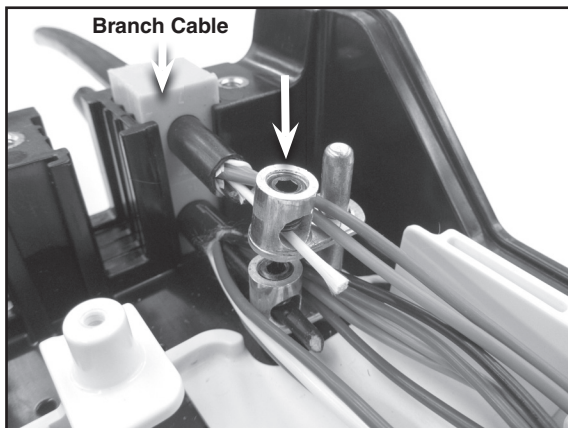
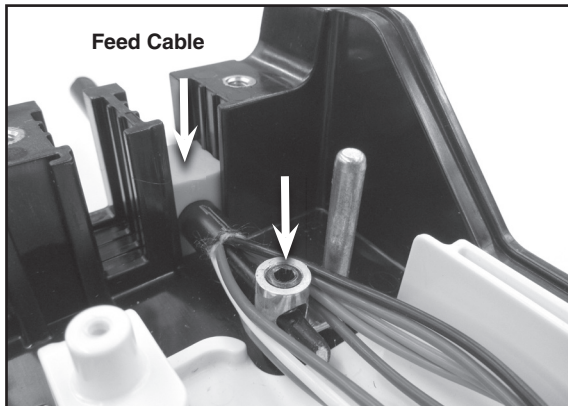

Step #14 If the cable contains Kevlar, place a self-tapping screw in the hole next to the grommet pocket and wrap the Kevlar around the screw. Tighten the screw to secure the Kevlar.

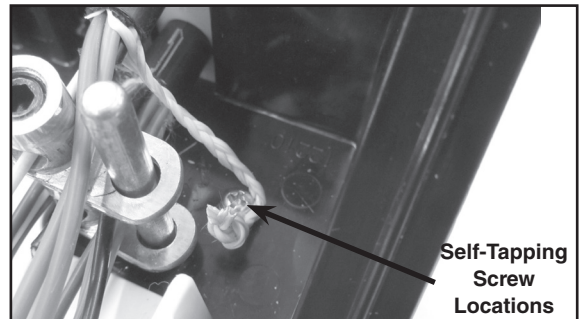

Step #15 Route any expressed buffer tubes under the tabs of the organizer.

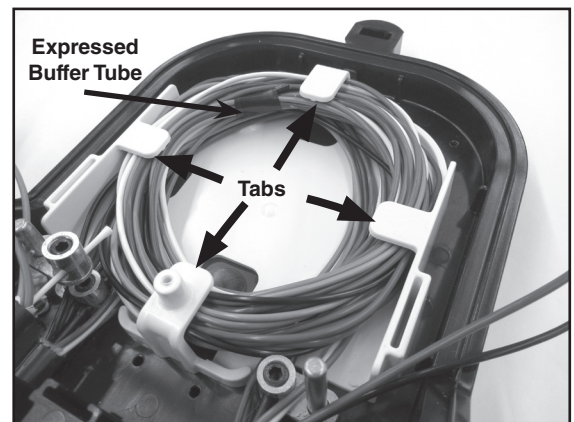

Splice Tray Organizer Installation

Step #16 Install tie wraps in the tie wrap slots of the splice tray organizer or place the foam retention blocks on the splice tray organizer as shown below.

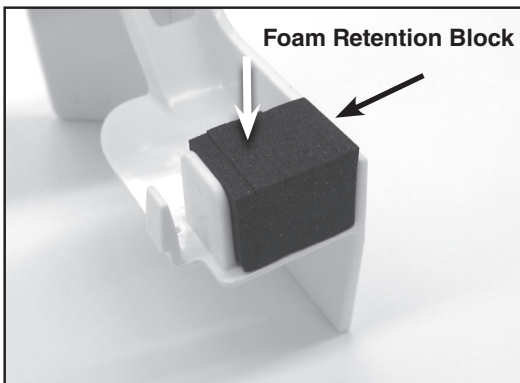
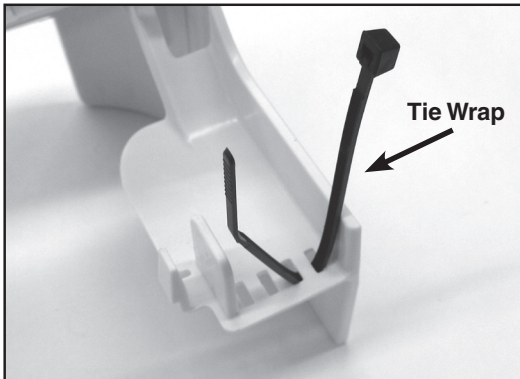

Standard Splice Tray Installation

Step #17 Place the first splice tray at the bottom of the hinge plate and position the splice tray perpendicular to the organizer as shown below.

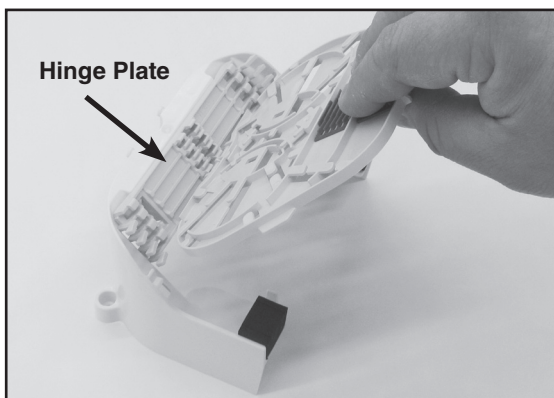

Step #18 Insert the hinge portion of the splice tray into the receiving portion of the hinge plate.



Reverse Splice Tray Installation

Step #19 Remove the hinge plate from the organizer by pushing in the spring tab of the hinge plate located underneath the organizer.

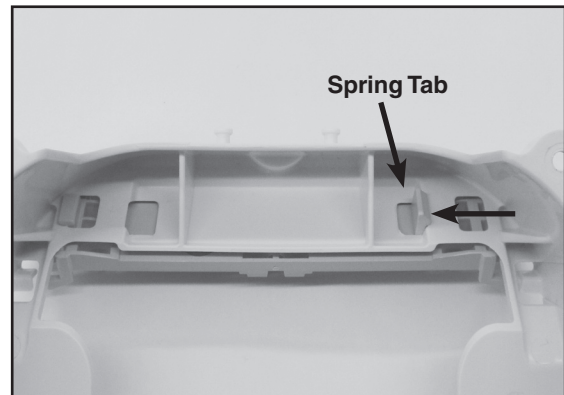

Step #20 Rotate the hinge plate 180 degrees and reinstall the hinge plate into the organizer.

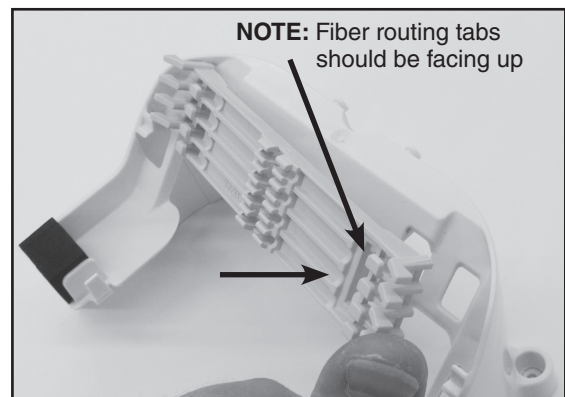

Step #21 Place the first splice tray at the bottom of the hinge plate and position the splice tray perpendicular to the organizer as shown below. Make sure that the back side of the splice tray is facing up.

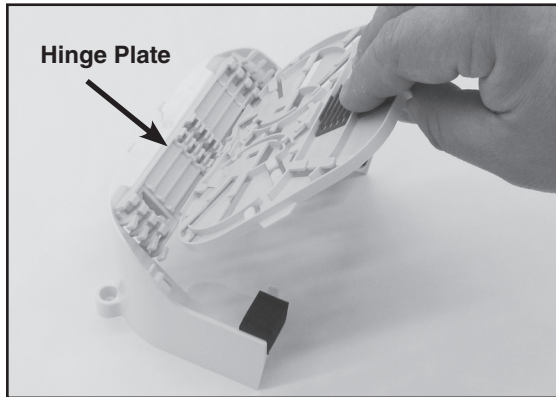

Step #22 Insert the hinge portion of the splice tray into the receiving portion of the hinge plate.

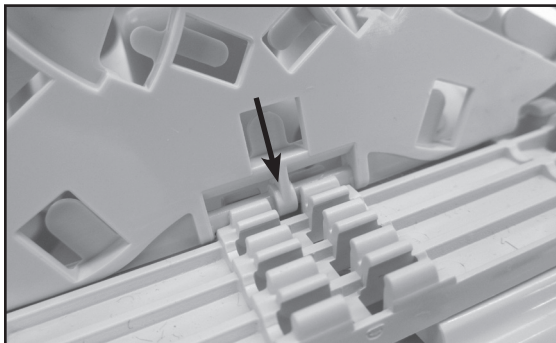

Securing the Splice Tray Organizer to the Base

Step #23 Secure the tray organizer to the base with the self-tapping screws that are provided.

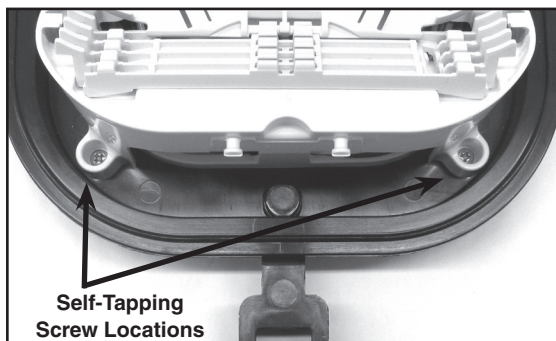

Buffer Tube/Fiber Routing for Feed & Branch Cables

Step #24 Mark and measure each buffer tube with fiber to be spliced in it 4" (10.2 cm) from the cable sheath opening. Remove the buffer tube past the mark.

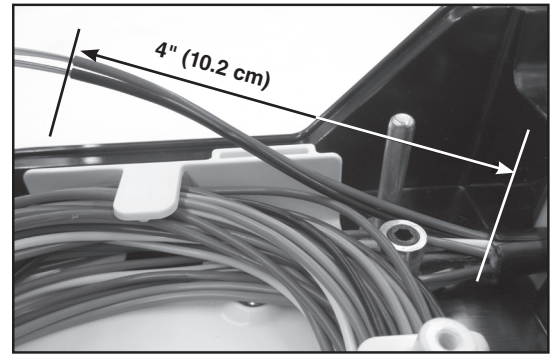

Step #25 Route any buffer tube with fibers to be spliced up to the splice tray organizer as shown below.

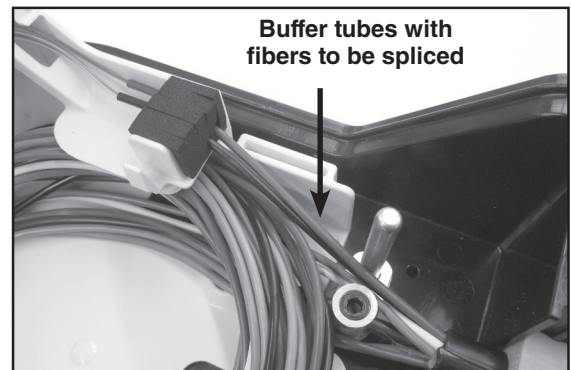

Step #26a Wrap the buffer tube(s) with felt and secure the buffer tube(s) to the organizer with a tie wrap.

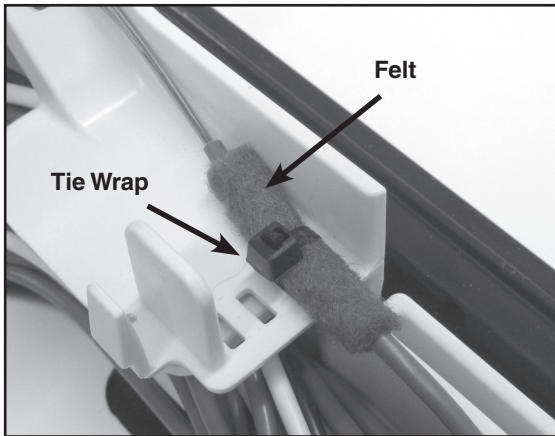

Step #26b Insert buffer tubes in the slots of the foam retention block.

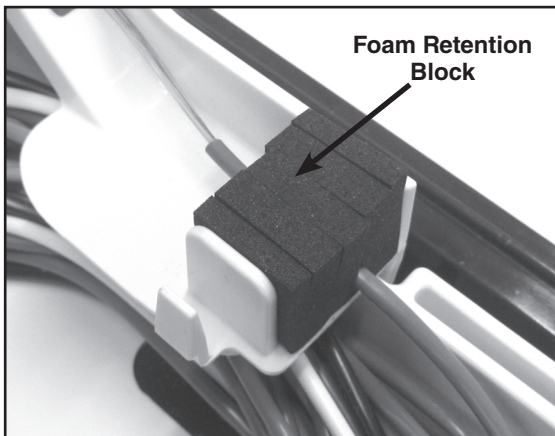

Step #27 Route feed fibers to be spliced up to the splice tray(s) and store them on the tray(s).

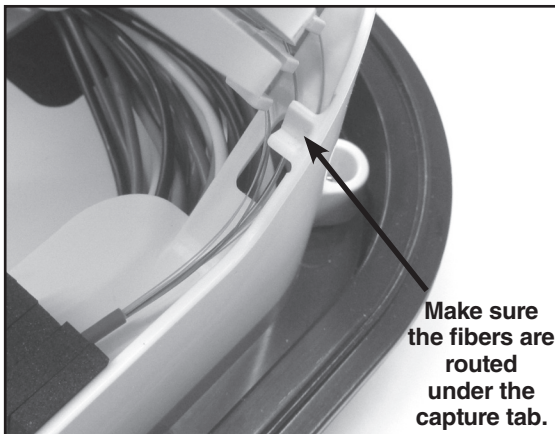

Drop Cable Preparation

Step #28 Measure each cable to determine the diameter of the cable and select the proper grommet(s) for your application.

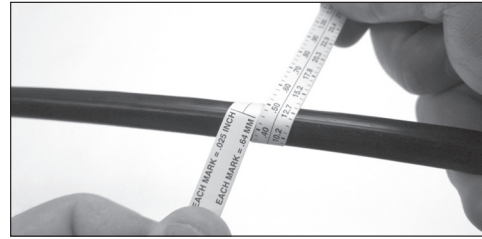

Slit Locations

Small Grommet Selection		Cable Diameter Range
A		SOLID / PLUG
B		.170" - .200" (4.3 - 5.1 mm) ROUND CABLES
C		.250" - .350" (6.4 - 8.9 mm) ROUND CABLES
D		.156" - .170" (4.0 mm - 4.3 mm) ROUND CABLES
E		.093" - .125" (2.4 - 3.2 mm) ROUND CABLES
F		FLAT DROP CABLE
G		.350" - .400" (8.9 - 10.2 mm) ROUND CABLES

Large Grommet Selection		Cable Diameter Range
J		.156" - .170" (4.0 mm - 4.3 mm) ROUND DROP CABLES
K		.093" - .125" (2.4 mm - 3.2 mm) ROUND DROP CABLES
L		FLAT DROP CABLES ONLY

Step #29 Insert the drop cables through the grommets as shown below.

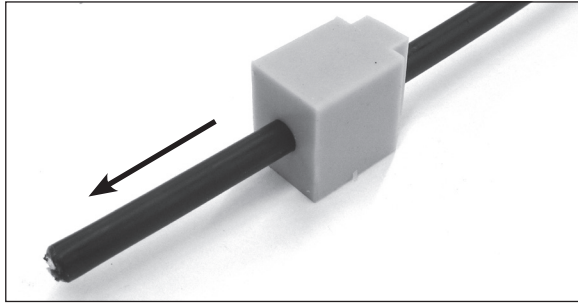

Step #32 Trim the strength members flush with the sheath opening.

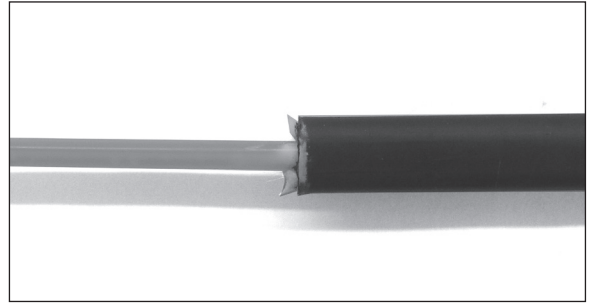

Step #30 If the cable has a tracer wire or is a figure 8 style cable, remove the tracer wire or messenger wire from the portion of the cable that will be positioned in the grommet and insert the cable into the grommet.

Cable with Tracer Wire

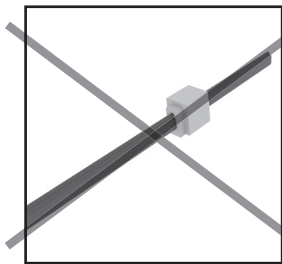

NOT CORRECT
INSTALLATION

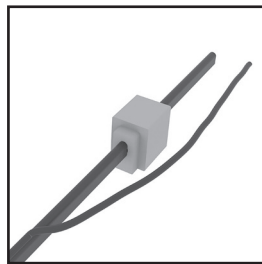

CORRECT
INSTALLATION

Figure 8 Style Cable

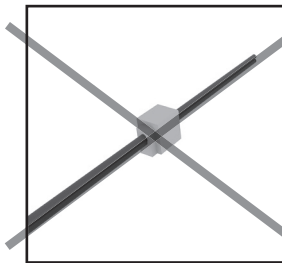

NOT CORRECT
INSTALLATION

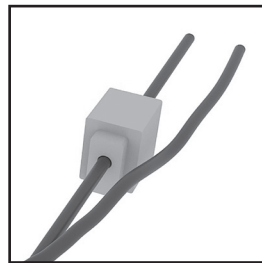

CORRECT
INSTALLATION

Step #31 Measure, mark, and remove the cable sheath for cut cable applications as shown below.



Step #33 Mark and remove the buffer tube 4" (10.2 cm) away from the sheath opening.

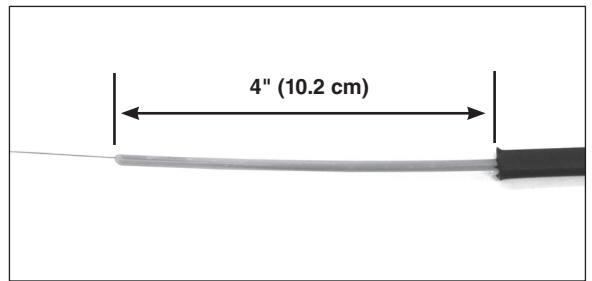

Step #34 Position the grommets roughly 1" (2.5 cm) away from the sheath opening.

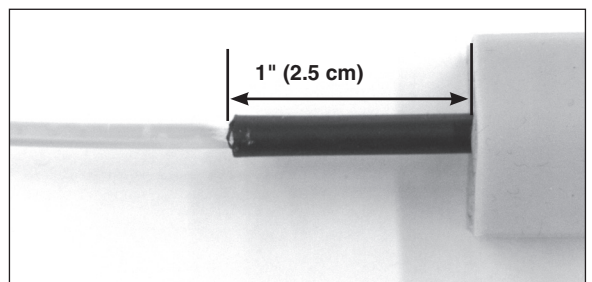

Step #35 Wrap a piece of felt around the round drop cables as shown below.

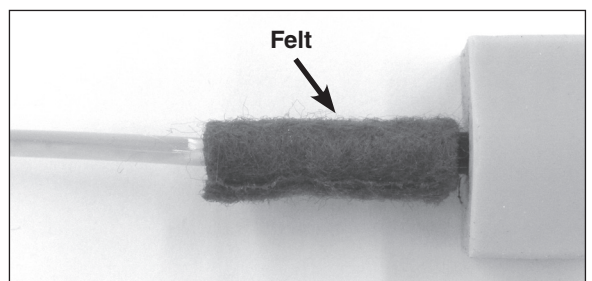

Step #36 Install plug(s) in any grommet that will not be used.

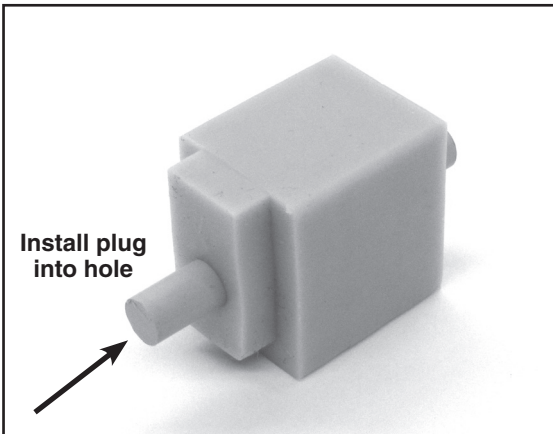

Step #37 Lubricate all four outer surfaces of each grommet. Once the lubricant has been applied, smear it to provide a light coating on each surface.

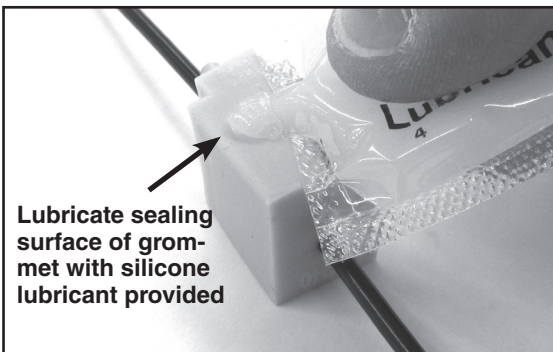

Round Drop Cable Retention

Step #38 Install the bottom layer of small grommets in the inside grommet pockets of the closure as shown below.

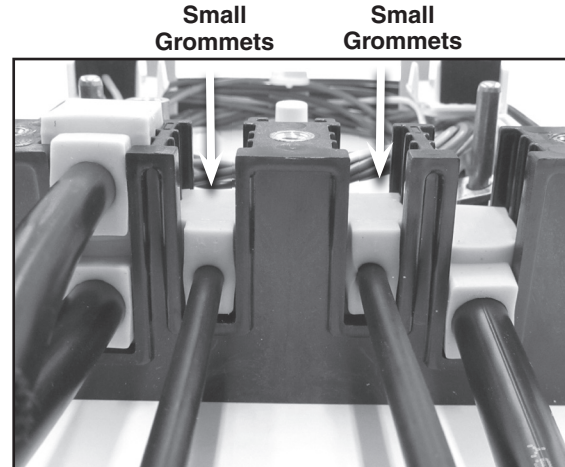

IMPORTANT NOTE: When installing the small grommets, position them in the pockets as shown below.

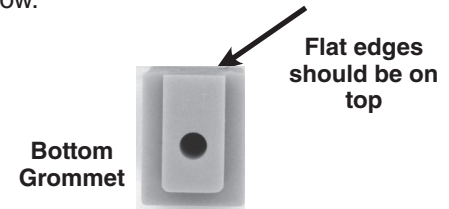

Step #39 Install the two position cable restraint bracket in the slot of the base as shown below. Use a cable tie wrap to secure the drop cable(s) to the restraint bracket.

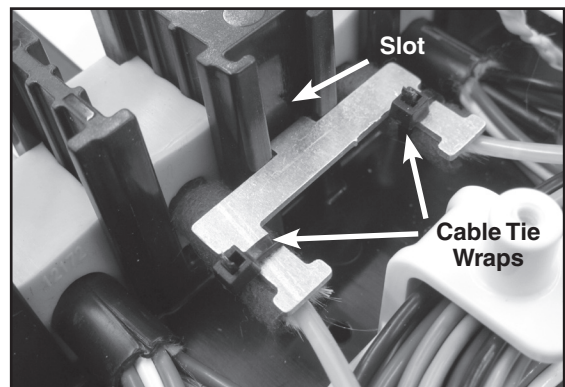

Step #40 Install the top layer of grommets into the closure. Insert the large grommets in the outside grommet pockets and the small grommets in the inside grommet pockets of the closure as shown below.

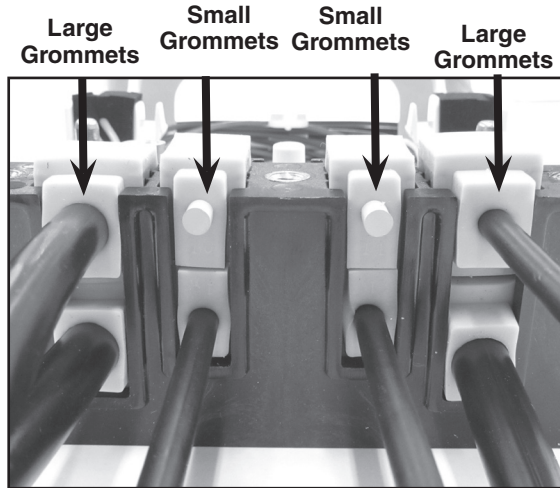

IMPORTANT NOTE: When installing the small grommets, position them in the pockets as shown below.

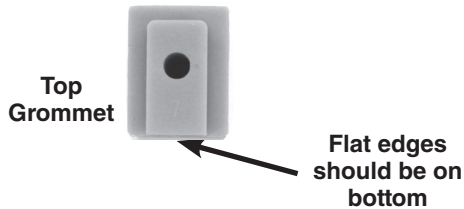

Step #41 Install the four position cable restraint bracket in the slot of the base as shown below. Use a cable tie wrap(s) to secure the drop cable(s) to the restraint bracket.

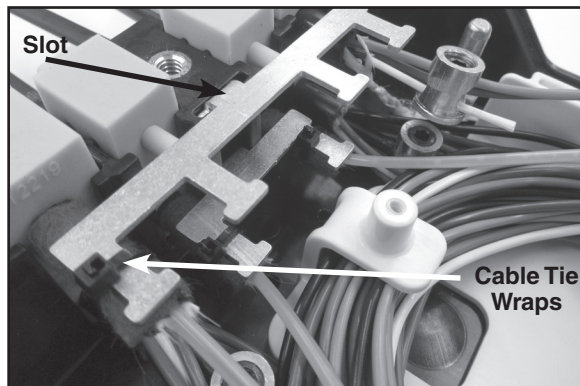

Flat Drop Cable Retention

Step #42 Insert the 2 position flat drop cable retention bracket into the central slot on the base.

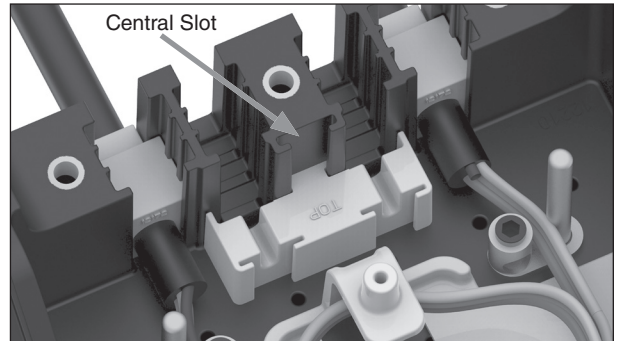

Step #43 Install the bottom layer of small grommets in the inside grommet pockets of the closure as shown below.

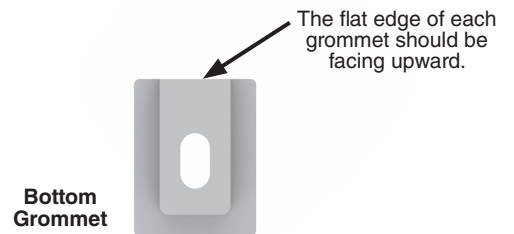
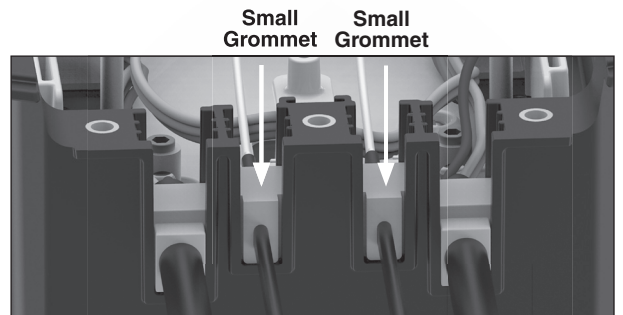

Step #44 Insert the single slot retention clips into the 2 position flat drop cable retention bracket as shown below.

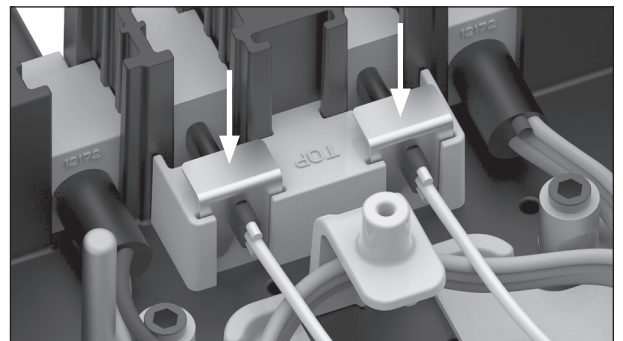

Step #45 Insert the 4 position flat drop cable retention bracket into the central slot on the base.

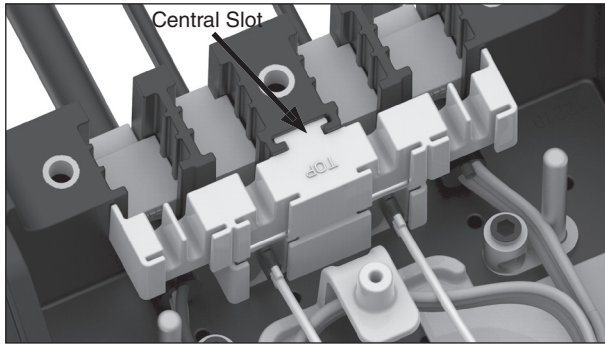

Step #48 Insert the single slot retention clips into the inner positions of the 4 position flat drop cable retention bracket as shown below.

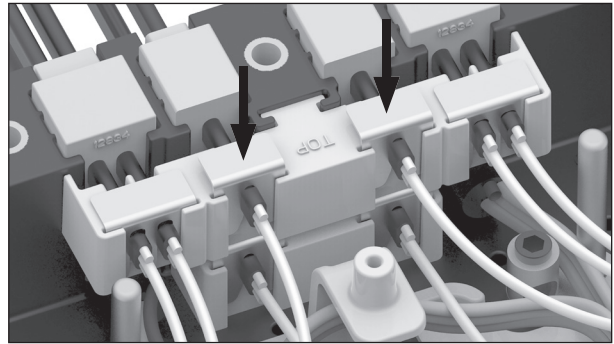

Step #46 Install the top layer of grommets into the base of the closure. Insert the large grommets in the outside grommet pockets and the small grommets in the inside grommet pockets of the closure as shown below.

Large Grommet Small Grommet Small Grommet Large Grommet

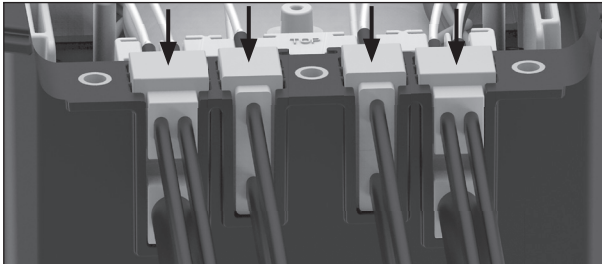

The flat edge of each grommet should be facing upward.

Bottom Grommet



Step #49 Install the end plate and secure with hex bolts.

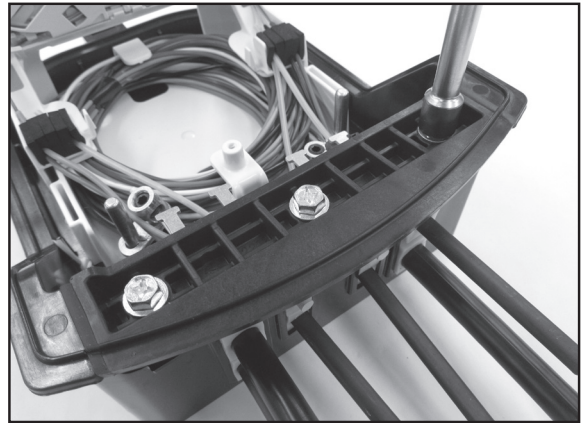

NOTE: Tighten bolts evenly by hand. DO NOT USE POWER TOOLS TO INSTALL THE COVER.

NOTE: When using a can wrench, nut driver, or Phillips screwdriver, the installed torque is 35 to 40 in-lbs.

Step #47 Insert the double slot retention clips into the outer positions of the 4 position flat drop cable retention bracket as shown below.

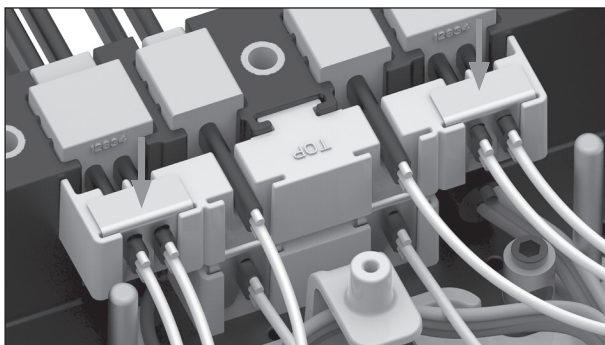

Buffer Tube & Fiber Routing for Drop Cables

Step #50 Route buffer tubes from drop cables as shown below.

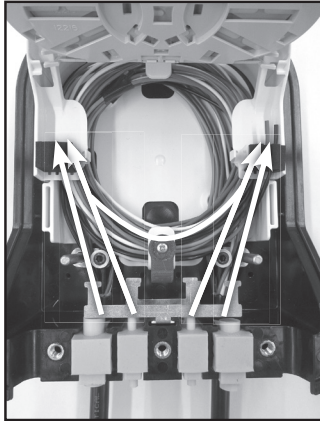

Step #51 Route fiber(s) tubes from drop cable(s) to splice trays.

Make sure fibers are routed under the capture tab.

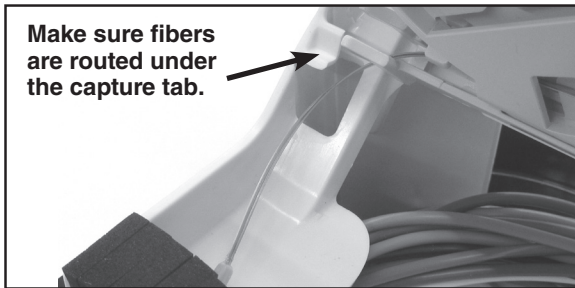

Fiber Routing on Splice Trays

Step #52 Route fibers on splice tray.

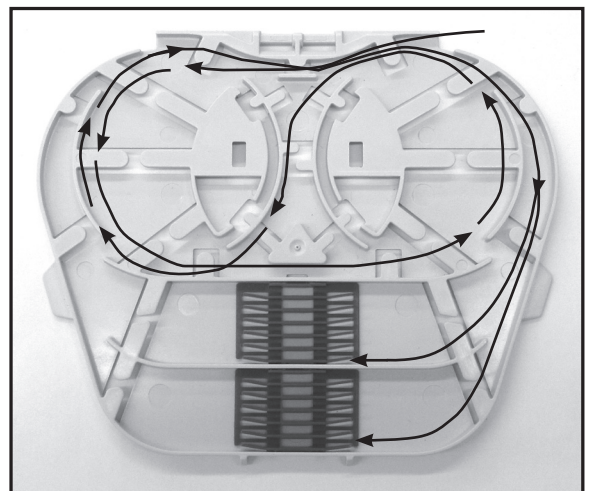
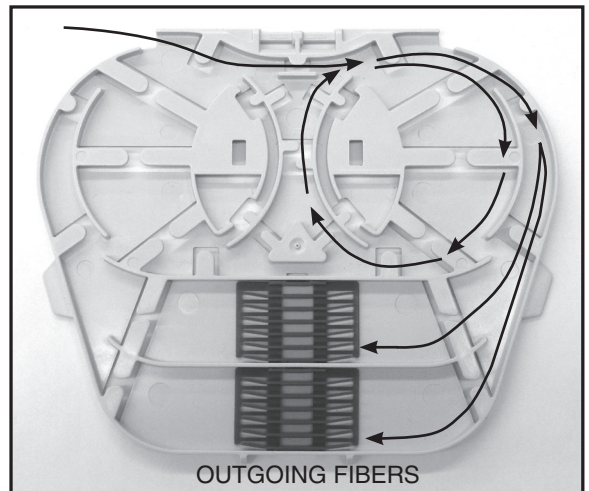
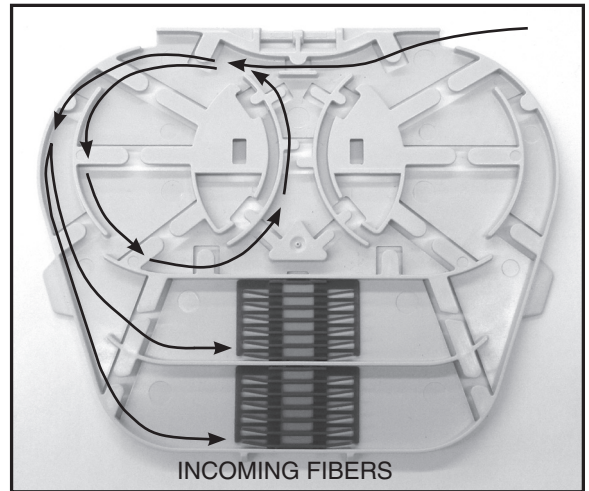

Step #53 Splice incoming fibers to outgoing fibers per your accepted company practice.

Supporting Splice Trays for Tray Access

Step #54 Install the ends of the tether onto the button heads on the organizer as shown below.

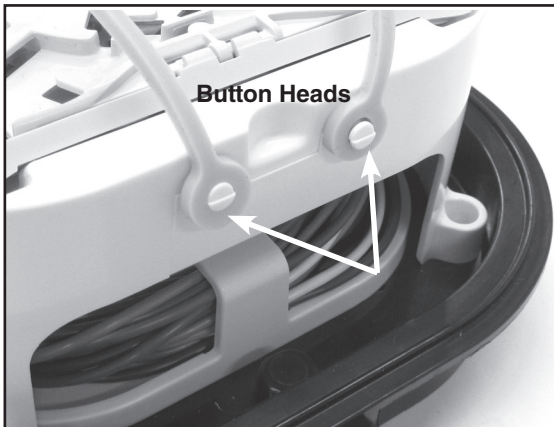

Step #55 Secure the trays in the upright position by wrapping the tether around the trays as shown below.

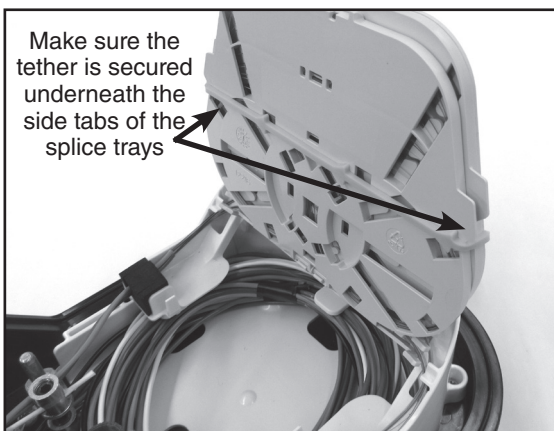

Securing Splice Trays

Step #56 Place the tray cover on the top tray. Make sure to verify that the cover is secured to tray.



Step #57 Install the ends of the tether onto the button heads on the organizer as shown below.

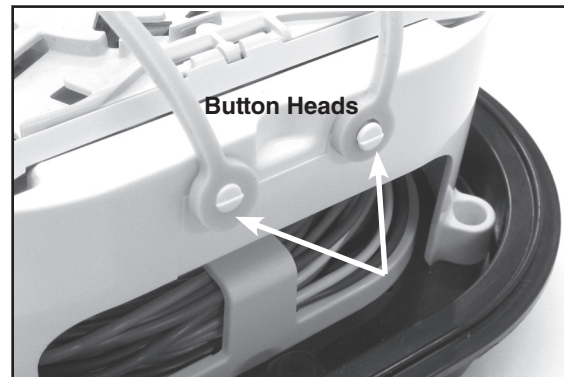

Step #58 Install the hook cap onto the boss located on top of the retention tab of the storage organizer. Secure the hook cap with a self-tapping screw.

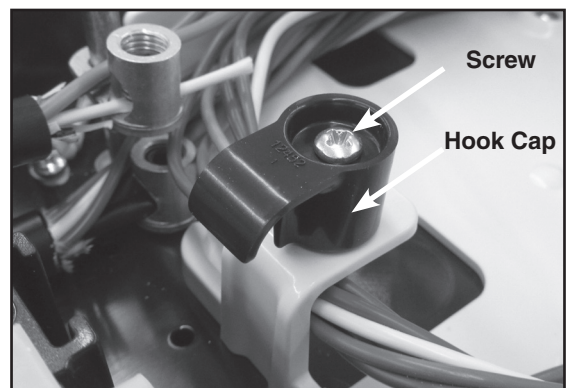

Step #59 Secure the splice trays by looping the tether around the hook cap as shown below.

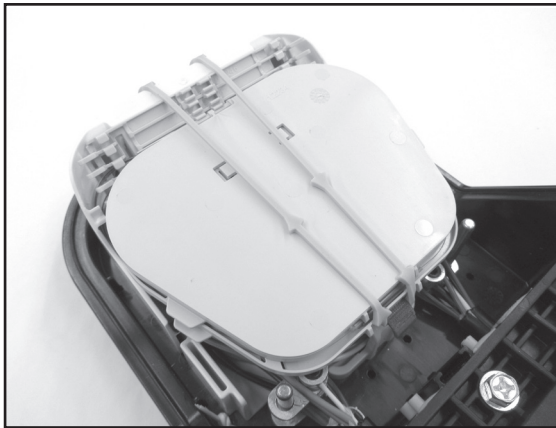
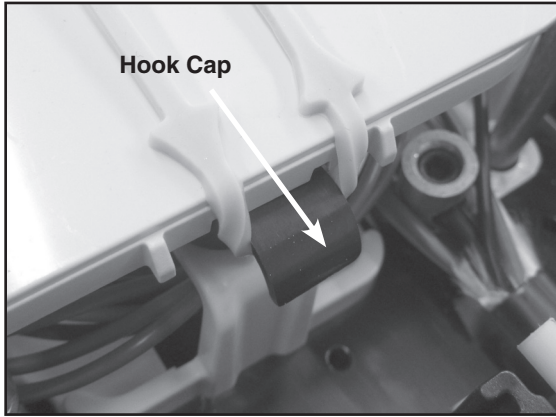

Bulkhead Tray Installation for Cross-Connect Applications

Step #60 Insert the bulkhead into the slots of the bulkhead tray and secure with the lock tab.

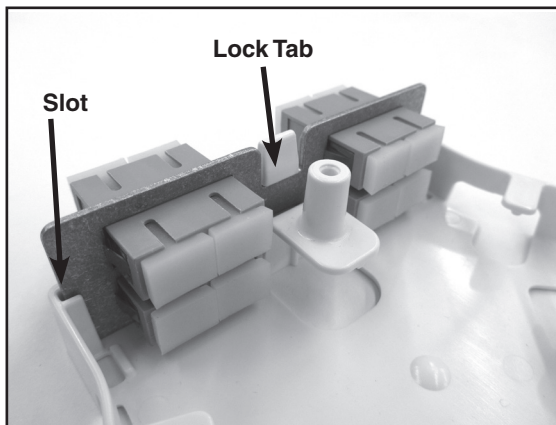

Step #61 Insert the pigtails through the side hole of the bulkhead tray as shown below.

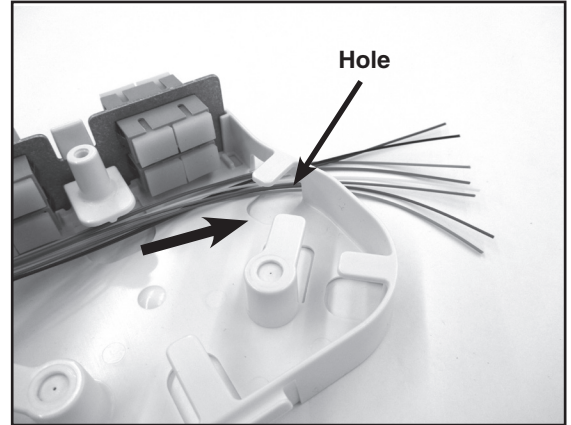

Step #62 Route the pigtails in the bulkhead tray as shown below.

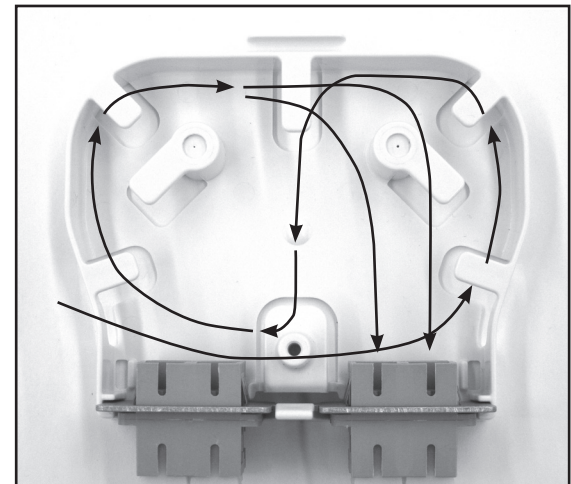
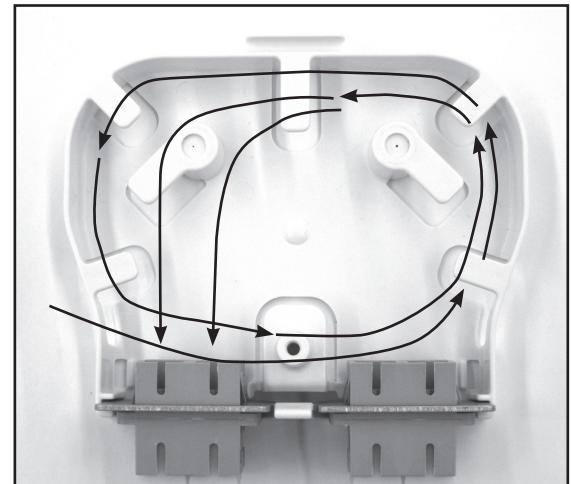

Step #63 Insert the bulkhead tray into the opening of the splice tray organizer until the retention tab of the bulkhead tray locks in place as shown below.

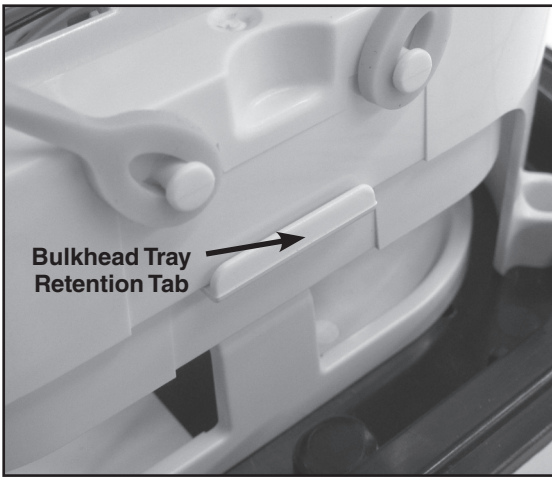
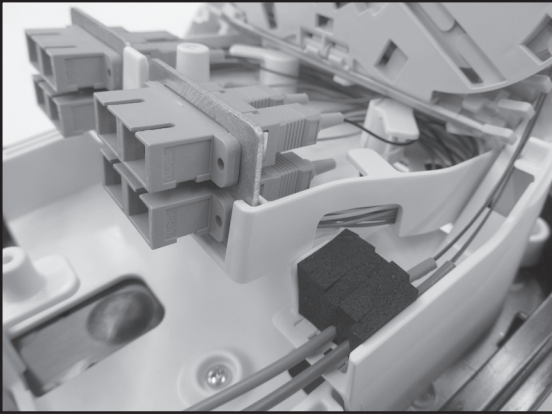

Step #64 Press down on the bulkhead tray to engage the tray into the retention tabs of the splice tray organizer.

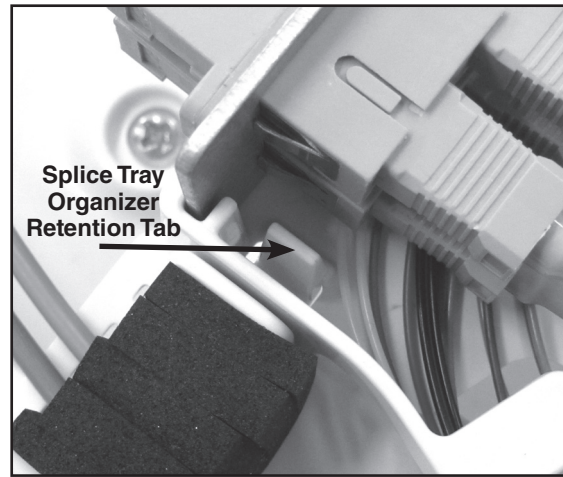
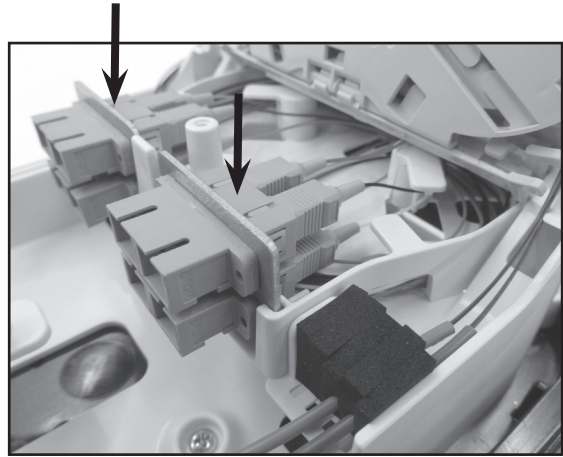

Step #65 Route the pigtails from the bulkhead tray to the splice trays.
NOTE: Only route 4 pigtails to each splice tray.

Make sure fibers are routed under the capture tab.

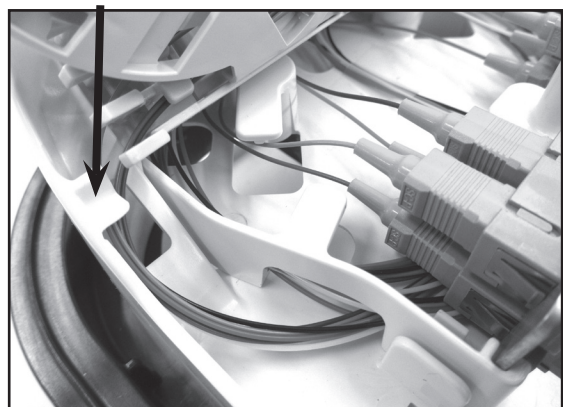

Pigtail/Fiber Routing on Splice Trays

Step #66 Route fibers on splice tray.

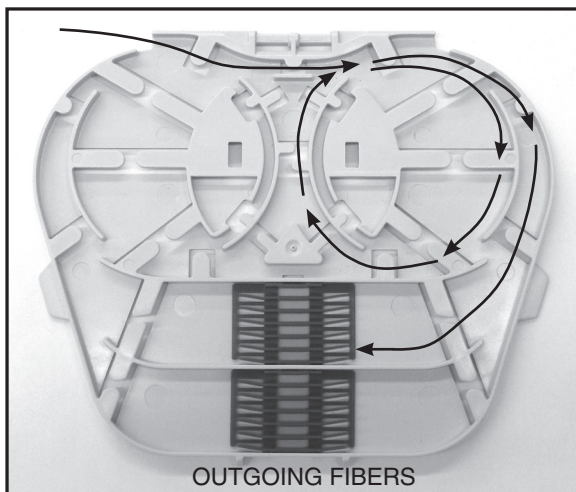
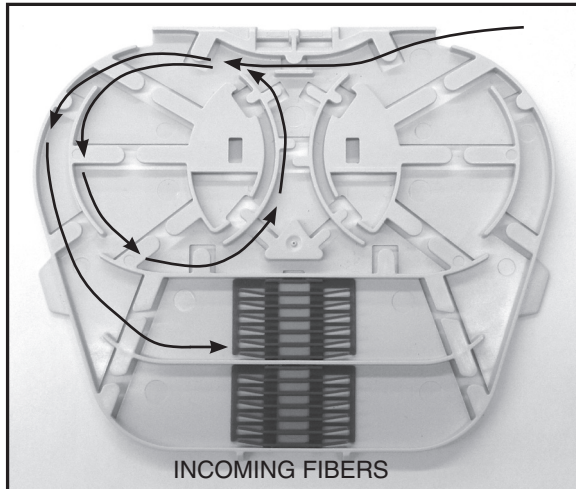

Step #67 Splice incoming fibers to outgoing fibers per your accepted company practice.

Connectorized Drop Installation

Step #68 Insert connectors of drop cable into the bulkhead as shown below.

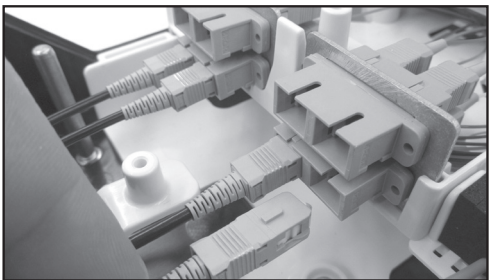

Cover Preparation and Installation

Step #69 Lubricate the sealing gasket of the cover with the silicone lubricant provided.



Step #70 Place the cover on the base.



Step #71 If the collar was removed from the base, re-insert the locking tab of the collar into the slot of the base.

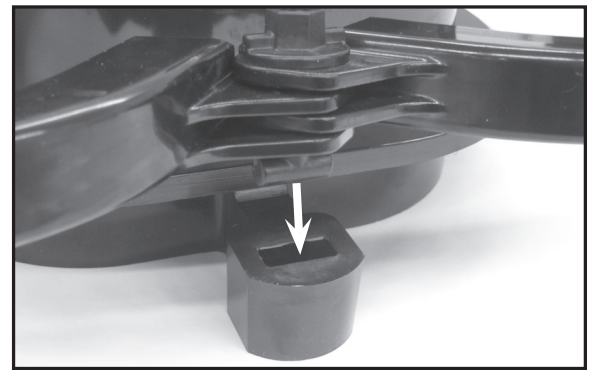

Step #72 Lock the collar to the base by twisting the collar fastener clockwise 90 degrees.

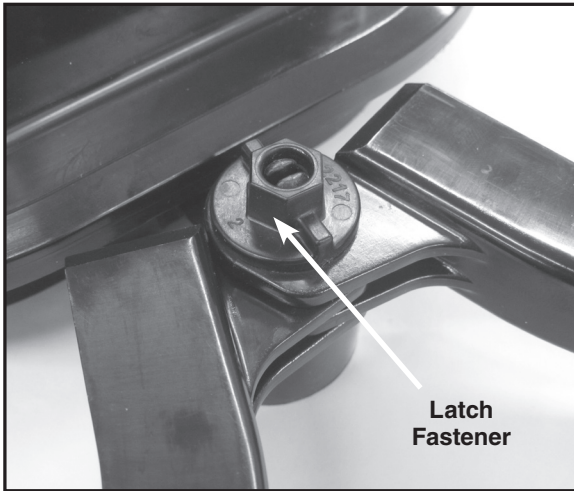

Step #74 Secure the collar latch and insert the pin into the latch.

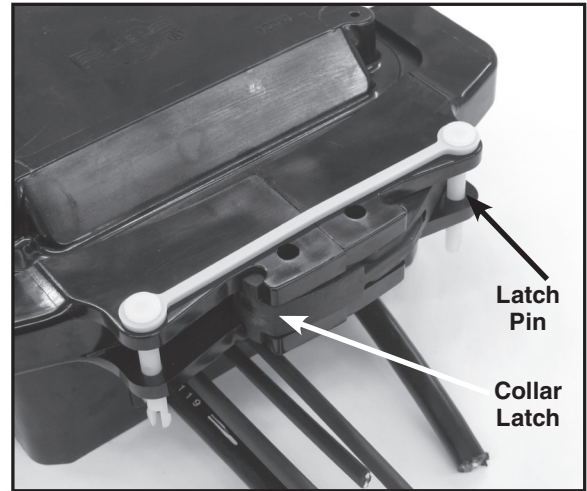

Step #73 Close the collar. Make sure that the lip of the base is secured under the collar when closing the collar.

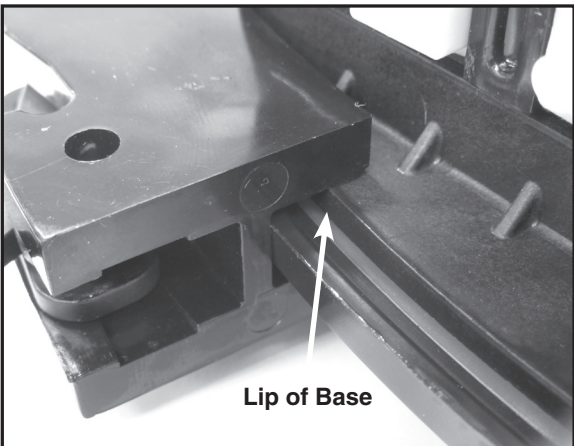
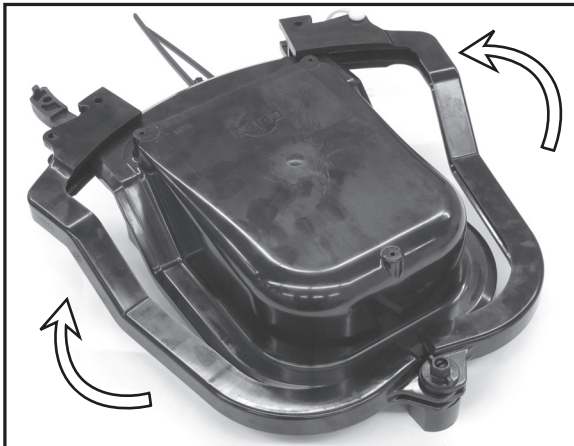

Cover Tether Option

Step #75 Secure the small hole end of the tether to the cover with the small self-tapping screw provided at one of the locations, as shown below.

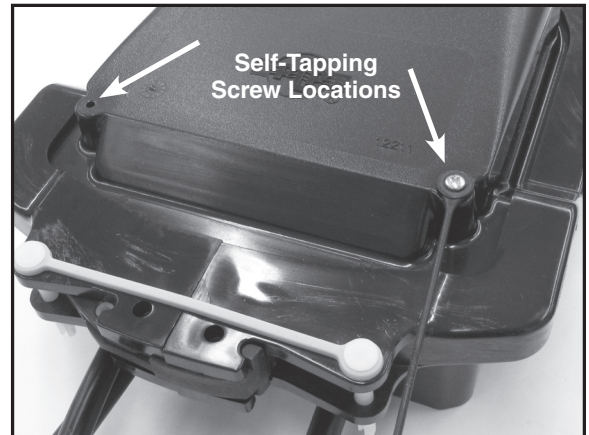

Step #76 Secure the large hole end of the tether to the back of the base with the large self-tapping screw provided at one of the locations, as shown below.

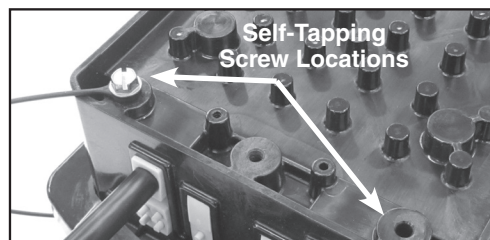

SAFETY CONSIDERATIONS

This application procedure is not intended to supersede any company construction or safety standards. This procedure is offered only to illustrate safe application for the individual. **FAILURE TO FOLLOW THESE PROCEDURES MAY RESULT IN PERSONAL INJURY OR DEATH.**

Do not modify this product under any circumstances.

This product is intended for use by trained technicians only. **This product should not be used by anyone who is not familiar with, and not trained to use it.**

When working in the area of energized lines, extra care should be taken to prevent accidental electrical contact.

For proper performance and personal safety, be sure to select the proper size PREFORMED™ product before application.

PREFORMED products are precision devices. To insure proper performance, they should be stored in cartons under cover and handled carefully.



PREFORMED LINE PRODUCTS

P.O. Box 91129, Cleveland, Ohio 44101 • 440.461.5200 • www.preformed.com • e-mail: inquiries@preformed.com
SP3269-2