

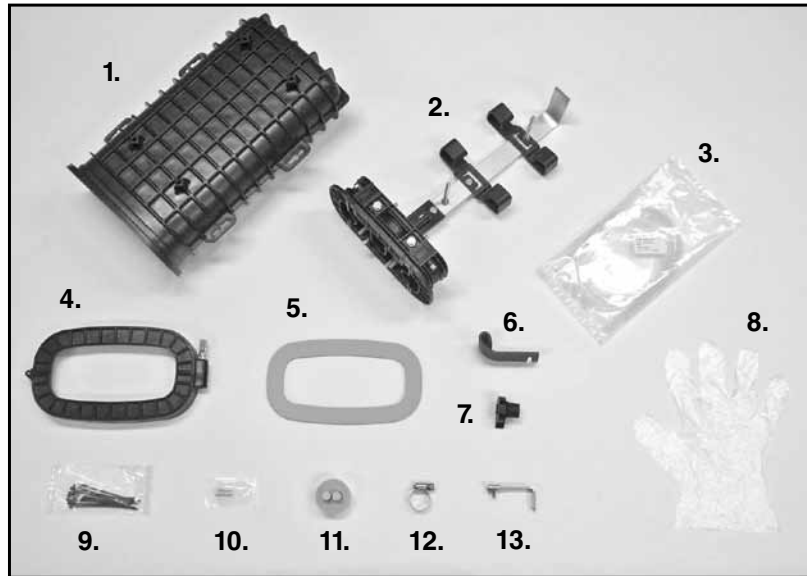

COYOTE® ONE Closure

Be sure to read and completely understand this procedure before applying product.
Be sure to select the proper PREFORMED™ product before application.



NOMENCLATURE







- | | | |
|---|--|--|
| 1. Dome Cover (1) | 4. Dome Collar (1) | 10. Silicone Lubricant (4 five gram packets) |
| 2. Organizer with 3-Port End Plate Assembly (Buffer Tube Organizer Shown) (1) | 5. Dome Gasket (1) | 11. Cable Grommet (3) |
| 3. Transport Tubing Kit (1) (In Universal Organizer Kit Only) | 6. Buffer Tube Side Storage Clip (2) (In Universal Organizer Kit Only) | 12. Hose Clamp (3) |
| | 7. 6-Hole Bobbin (1)* | 13. Short Strength Member Bracket (3) |
| | 8. Disposable Glove (1) | |
| | 9. Cable Tie Wraps (1 Bag) | |

*Accessory can be purchased separately.

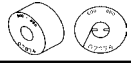

TOOLS REQUIRED

- 3/8" & 7/16" Can wrench or socket
- 1/4" Nut driver or screwdriver
- Snips
- Fiber optic cable opening tools

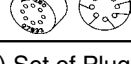
COYOTE® ONE Closure Kits	
Catalog Number	Description
COY1-001	COYOTE ONE Closure for Buffer Tube Applications. Includes: (3) Grommets - (2) P/N: 8003663 & (1) P/N: 8003665, (1) Organizer Assembly with 3-Port End Plate, (1) Collar Assembly, (1) Gasket, & (1) Small Parts Bag
COY1-002	COYOTE ONE Closure for Unitube/Ribbon Applications. Includes: (3) Grommets - (2) P/N: 8003663 & (1) P/N: 8003665, (1) Organizer Assembly with 3-Port End Plate, (1) Collar Assembly, (1) Gasket, (1) Small Parts Bag, & (1) Transition Tube Kit
Mounting Brackets and Accessories	
8004005	Aerial Low Clearance Mounting Bracket (Dome Mount) - Strand Mounting
8004031	Aerial Low Clearance Mounting Bracket (Dome Mount) - ADSS Mounting
8004027	Aerial Offset Mounting Bracket (Dome Mount) - Strand Mounting
8004032	Aerial Offset Mounting Bracket (Dome Mount) - ADSS Mounting
8004004	Pole/Wall Mounting Bracket
8003835	Universal Mounting Bracket Kit for Hand Hole Applications
8004033	Provides flat surface to apply closure identification labels

COYOTE® ONE Grommet Chart			
For use in COYOTE® GLC, Aerial, LCC, Dome, In-Line RUNT, Taut & Terminal Closures			
PLP Catalog Number	Cable Range Inches (mm)	Description	Slitting Location
8003691	.42 - .60 (11 - 15 mm)	1-entry grommet	
8003692	.60 - .85 (15 - 22 mm)	1-entry grommet	
8003663	.42 - .60 (11 - 15 mm)	2-entry grommet	
8003664	.30 - .43 (8 - 11 mm)	4-entry grommet	
8003989	Flat Drop Only	4-entry grommet	
8003665	.125 - .25 (3 - 6 mm)	6-entry grommet	
8003676	.42 - .60 (11 - 15 mm) .125 - .25 (3 - 6 mm)	7-entry grommet	
8003677	.125 - .25 (3 - 6 mm)	8-entry grommet	

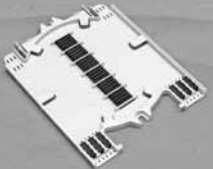
NOTE: Grommet Kit contains (1) Grommet, (1) Cable Measure Tape, (2) Silicone Lubricant Packs, (1) Set of Plugs & (1) Glove

Splice Tray/Closure Capacities for COYOTE® ONE Closure					
Splice Tray	Catalog Number	Splice Type	Trays per Closure	Closure Splice Capacity	
	Low Profile LITE-GRIP® (24 ct.)	80809958	Single Fusion	4 (Universal Version)	96
				5 (Buffer Tuber Version)	120
	Deep Profile LITE-GRIP® (40 ct.)	80808945	Single Fusion	2	80
	Deep Profile LITE-GRIP® (144 ct.)	LGSTR144	Mass Fusion/ Ribbon	2	144 Suggested 288 Max

Cable Preparation

Step #1 Measure cable to determine diameter and hole location to use in grommet.



Step #2a If using cut cable, insert cable through grommet. If your application requires express/balloon/ring cut cables, **see Step 3 for grommet slitting procedure.**

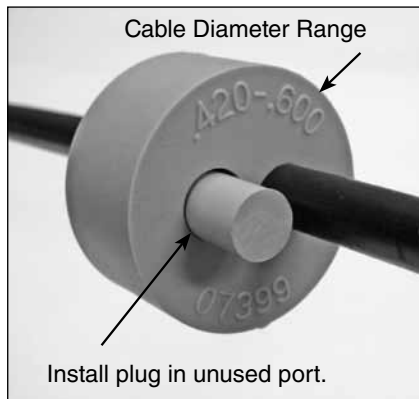

Step #2b **Installing Figure 8 Style Cables and Cables with Tracer Wires** - Remove tracer wire or ground wire from the portion of the cable that will be positioned in the grommet and insert cable into grommet.

Cable with Tracer Wire



Not Correct Installation



Correct Installation

Figure 8 Style Cable



Not Correct Installation



Correct Installation

Step #3 **Grommet Slitting** – If slitting is required, lay grommet on a stable flat surface. Position utility knife with the cutting edge against the top surface and cut through grommet. **Consult grommet chart on page 2 for slitting locations of all grommets.**

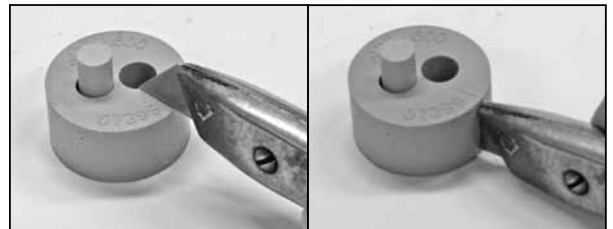

PLP Tip: Use a pen to sketch slitting lines on top surface of grommet prior to cutting.

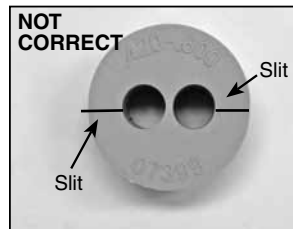

Not Correct Slitting Angle

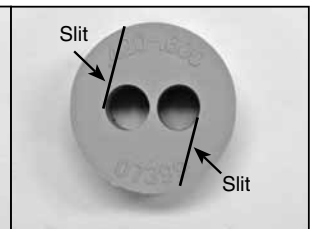

Correct Slitting Angle

Step #4 Prepare loose tube/buffer tube or unitube/
ribbon cable(s) for cut applications.

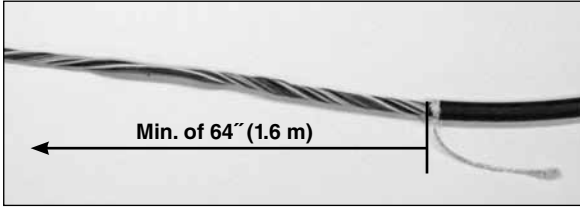

**Minimum Sheath Opening for Cut
Cable Applications**

64"	1.6 m
-----	-------

PLP Tip: Leave about 8" (203 mm) of strength
member to trim later.

**Cable Sheath Opening for Applications Where
Fiber is Dedicated to the Splice Point**

Step #5a Prepare loose tube/buffer tube or unitube/
ribbon cable(s) for mid sheath applications
(Express/Balloon/Ring Cut).

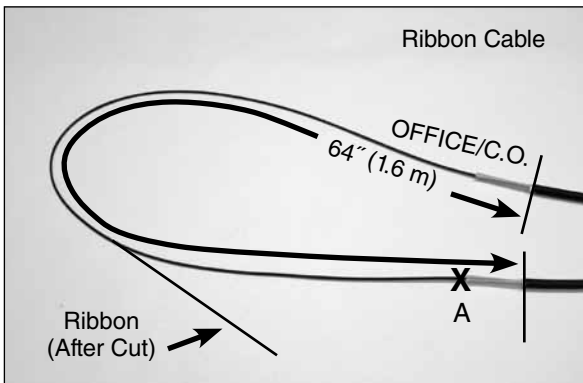
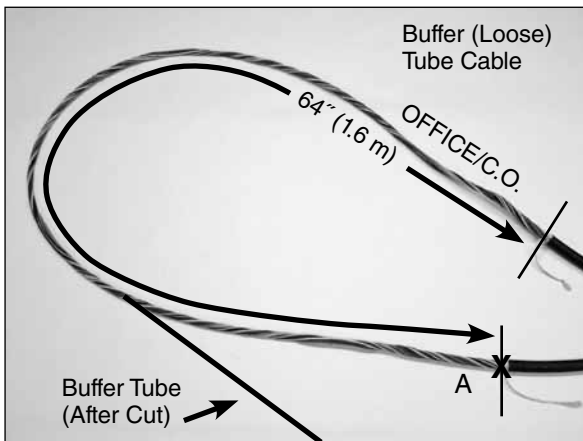

NOTE: When expressing ribbons in the transition tray of
the closure at this measurement, the maximum number of
ribbons that can be expressed is 24 ribbons (288 fibers).

**For Applications Where Fiber is
Dedicated to the Splice Point**

Sheath Opening	Min. of 64" (1.6 m)
Fiber/Buffer Tube Cut Location	A (see image above)

PLP Tip: Leave about 8" (203 mm) of strength
member to trim later.

**Cable Sheath Opening for Applications Where
Fiber is NOT Dedicated to the Splice Point**

Step #5b Prepare loose tube/buffer tube or unitube/
ribbon cable(s) for mid sheath applications
(Express/Balloon/Ring Cut).

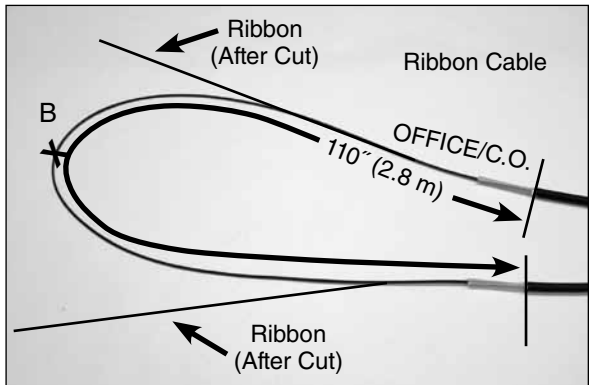
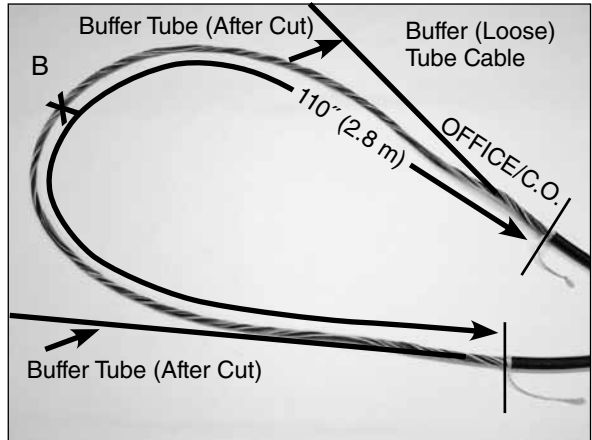

NOTE: When expressing ribbons in the transition tray of
the closure at this measurement, the maximum number of
ribbons that can be expressed is 12 ribbons (144 fibers).

**For Applications Where Fiber is
NOT Dedicated to the Splice Point**

Sheath Opening	Max. of 110" (2.8 m)
Fiber/Buffer Tube Cut Location	B (see image above)

PLP Tip: Leave about 8" (203 mm) of strength
member to trim later.

Cable Sheath Opening for Applications Where Fiber is Expressed through the Buffer Tube

Step #5c Prepare loose tube/buffer tube cable(s) for expressed fiber (buffer tube window cut).

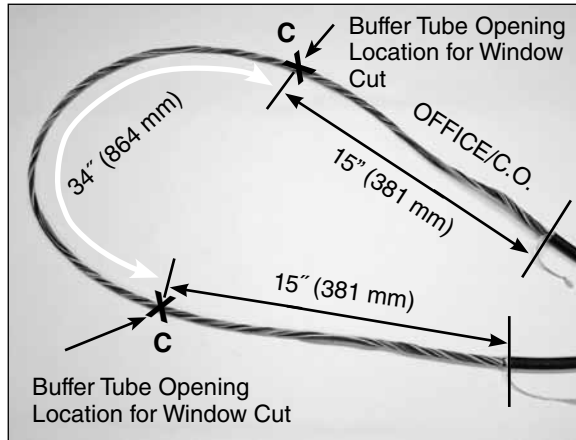

For Applications Where Fiber is Expressed through the Buffer Tube	
Sheath Opening	64" (1.6 m)
Buffer Tube Opening Location	C (see image above)

PLP Tip: Leave about 8" (203 mm) of strength member to trim later.

Step #6 Prepare Central/Buffer Tube(s) for Unitube/Ribbon Cable Applications.

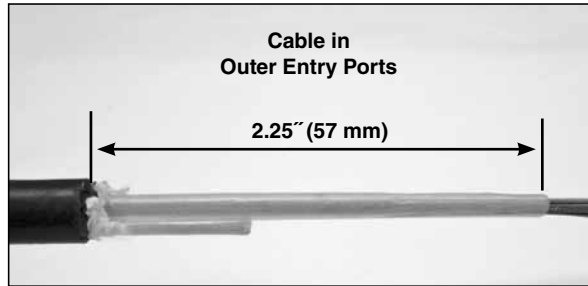

Step #7 If the cable contains Kevlar®, braid roughly 3" (7.2 cm) of the Kevlar.

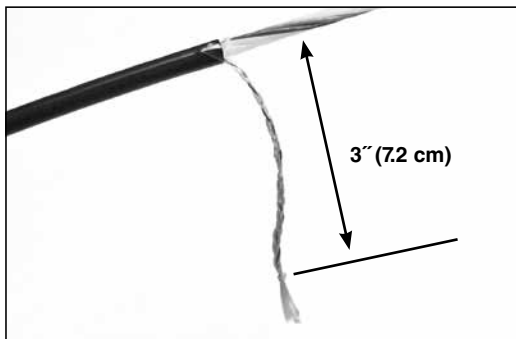

Attaching Cables to Strength Member Bracket

Step #8a Align sheath opening with end of slot of the strength member bracket as shown.

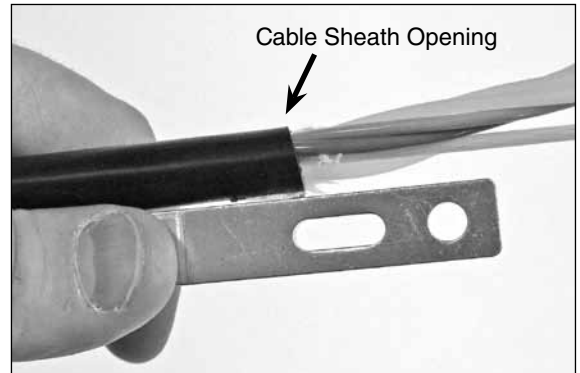

Step #8b Trim strength member(s) flush with end of the strength member bracket(s).

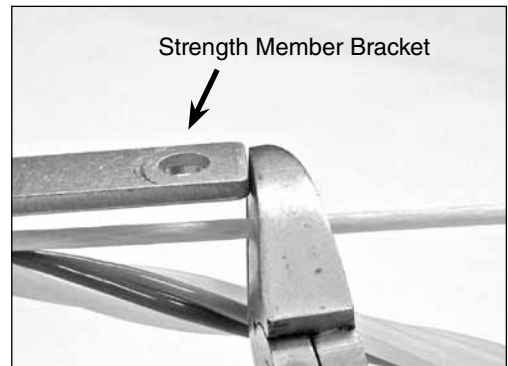

Step #9 Install cap on strength member bracket.

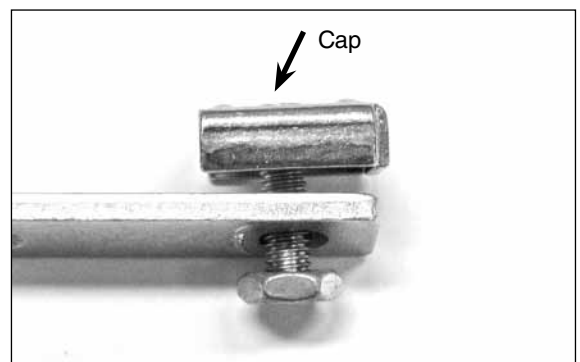

Step #10 Position strength member under cap of strength member bracket.

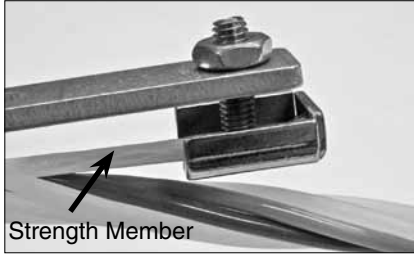

Step #11 If the cable contains Kevlar®, wrap the braided Kevlar around the stud of the cap as shown.

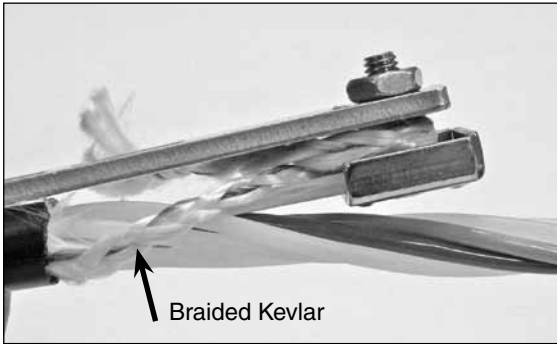

Step #12 Tighten nut of cap to secure strength member and braid under the cap.

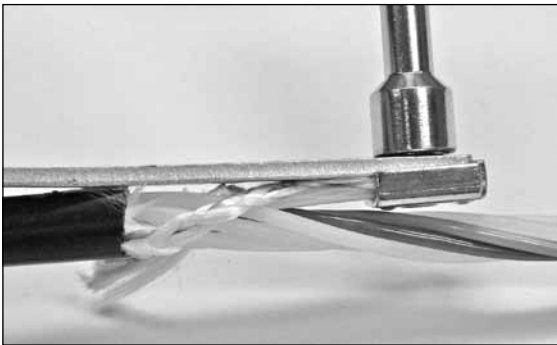

Step #13 Secure cable to strength member bracket with hose clamp.



Attaching Shielded Cable to Strength Member Bracket

Step #14a For shielded cable applications, PLP recommends using a 3M 4460-D/FO Fiber Optic Shield Connector (PN: 80803989). Install shield connector on cable and insert stud of shield connector through slot of strength member bracket.

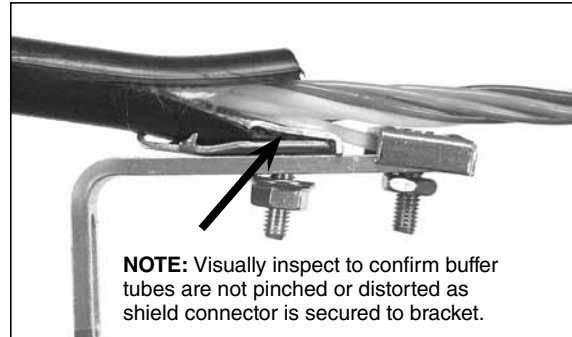

NOTE: Visually inspect to confirm buffer tubes are not pinched or distorted as shield connector is secured to bracket.

Follow standard company practices when applying shield connector to cable.

Step #14b Secure shield connector to strength member bracket with nut and secure cable strength member under cap of the strength member bracket.

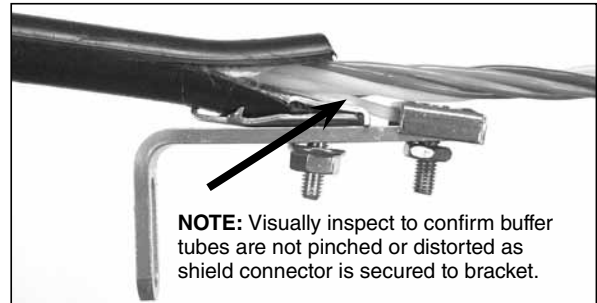

NOTE: Visually inspect to confirm buffer tubes are not pinched or distorted as shield connector is secured to bracket.

Step #14c Secure shielded cable to strength member bracket with hose clamp.

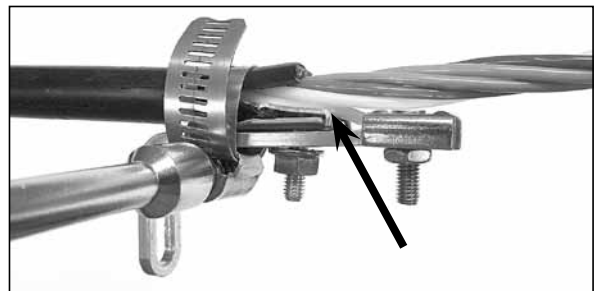

NOTE: Visually inspect to confirm buffer tubes are not pinched or distorted as cable is secured to bracket with hose clamp.

Step #15a Lubricate the outer surface of the grommet.

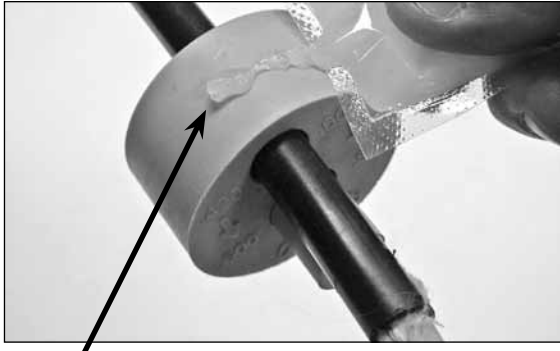

Lubricate sealing surface of grommet with silicone lubricant provided.

Step #15b Position grommet in end plate slot.

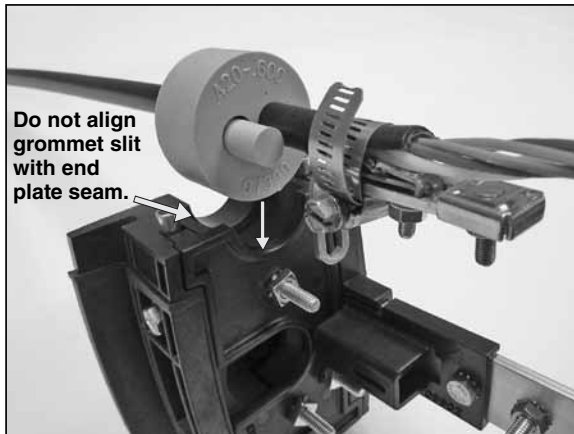

Do not align grommet slit with end plate seam.

Step #16 Position slot of strength member bracket leg over stud and pull back cable.

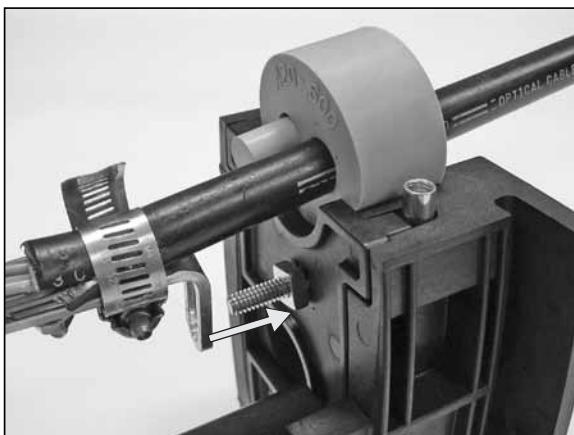

Step #17a Lightly secure strength member bracket on stud with lock washer and nut, allowing bracket to move.

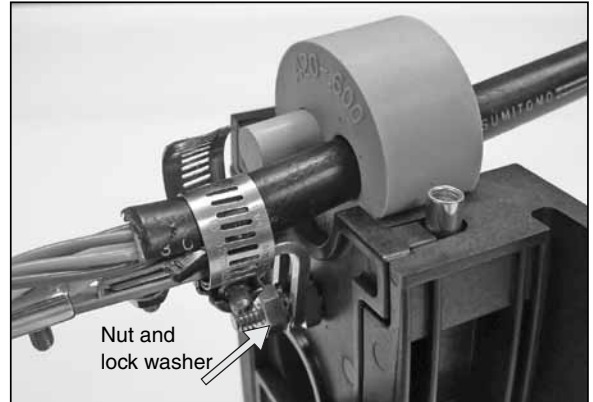

Nut and lock washer

Step #17b Install the cable end cap and secure with hex bolts.

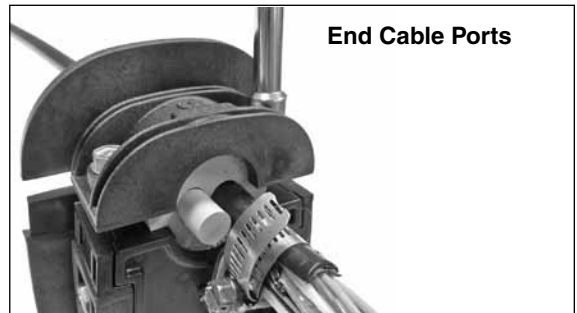

End Cable Ports

NOTE: Tighten bolts by hand, evenly until cable cap is fully seated (Do Not Use Power Tools to Tighten Bolts) Repeat process for remaining end cap. When using a can wrench or nut driver the installed torque is 35 to 40 in. lbs.

IMPORTANT: TIGHTEN AND SECURE THE STRENGTH MEMBER BRACKET

Step #17c Small guide tabs are on each end plate cap to insure proper alignment during end plate assembly. See assembly images below.

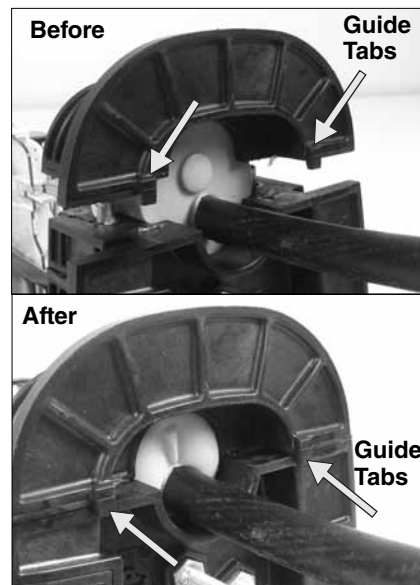

Before

Guide Tabs

After

Guide Tabs

Attaching Drop Cables to 6-Hole Grommet Bobbin

Step #18 Trim strength members of drop cables as shown.

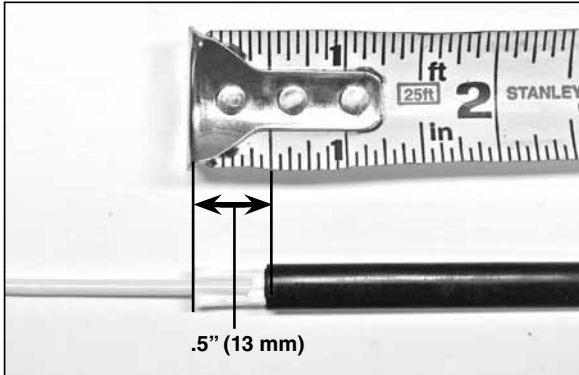

Step #19a Place end(s) of strength member(s) in the retention pocket of the bobbin.

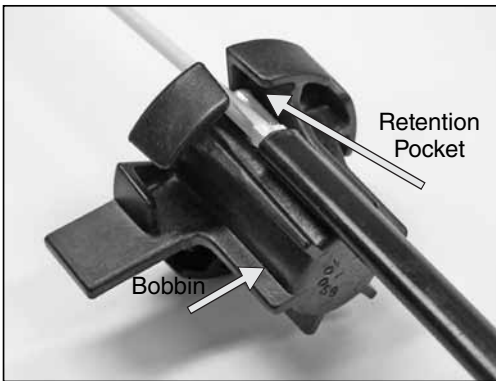

Step #19b Secure cable(s) to bobbin with hose clamp.



Center Cable Cap Installation

Step #20a For cables entering the closure in the middle cable port, insert the leg of the bobbin in the slot of the bobbin bracket.

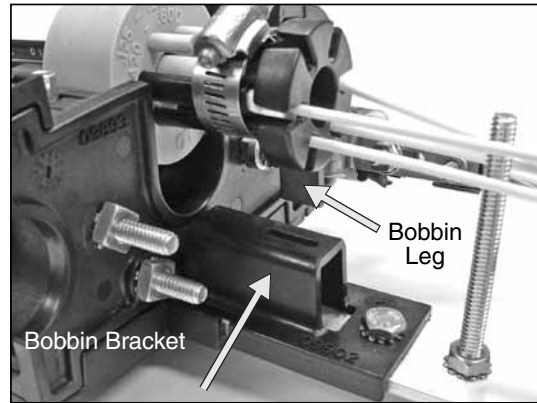

Step #20b For cables entering the closure in the outer cable ports, place the leg of the bobbin in the slot of the strength member bracket and lightly secure the strength member bracket on the stud. The bracket is not tightened down yet.

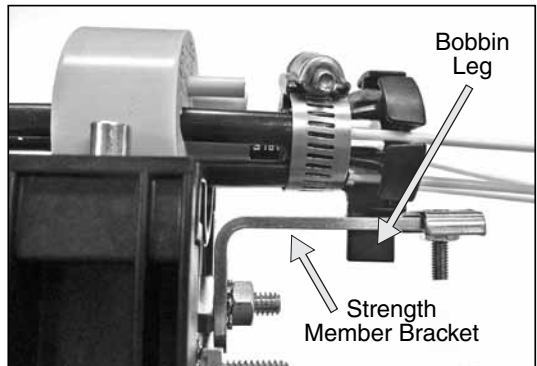

Step #21a Install center cable caps and secure with hex bolts.

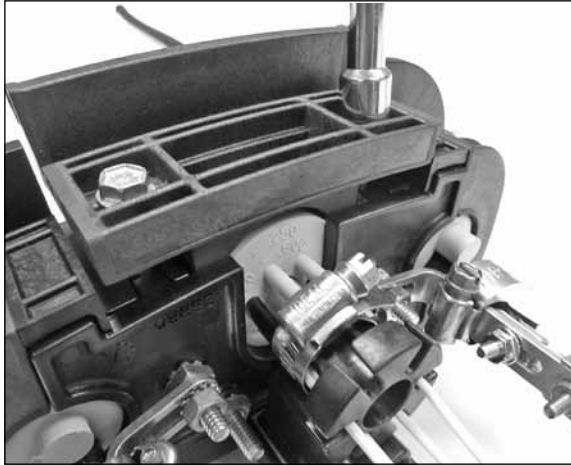

NOTE: Tighten bolts by hand evenly until cable cap is fully seated (**DO NOT USE POWER TOOLS TO TIGHTEN BOLTS**). When using a can wrench or nut driver, the installed torque is 35 to 40 in. lbs. **IMPORTANT: TIGHTEN AND SECURE THE STRENGTH MEMBER BRACKET**

Step #21b Small guide tabs are on each end plate cap to insure proper alignment during end plate assembly. See assembly images below.

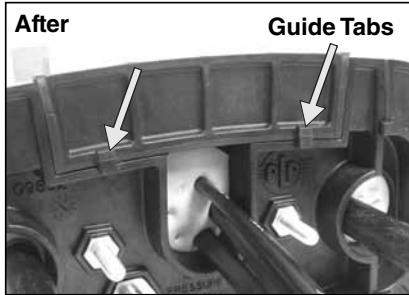
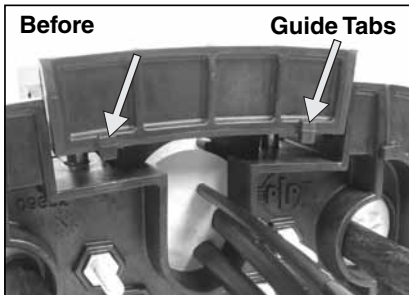

Step #22 Complete end plate assembly.



Routing in Buffer Tube Organizer

Step #23 Route and store buffer tubes in storage brackets.

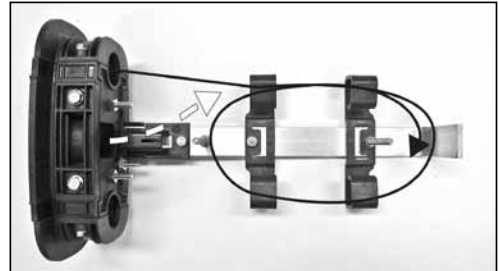
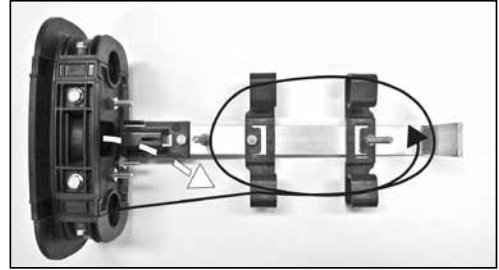

Step #24 Route buffer tube(s) to splice tray(s) and secure.

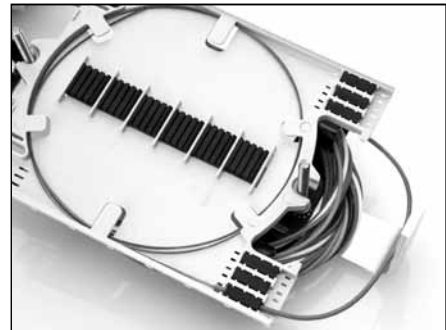

Routing in Universal Organizer for Buffer Tube Applications

Step #25 Secure buffer tube storage brackets with nut and lock washer.

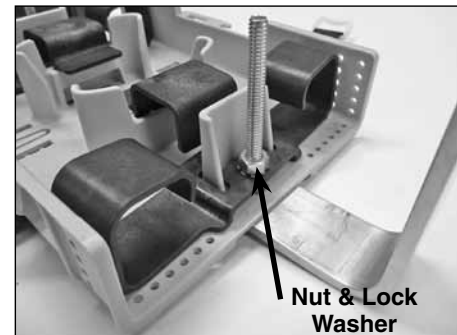

Step #26 Route and store buffer tubes in storage brackets.

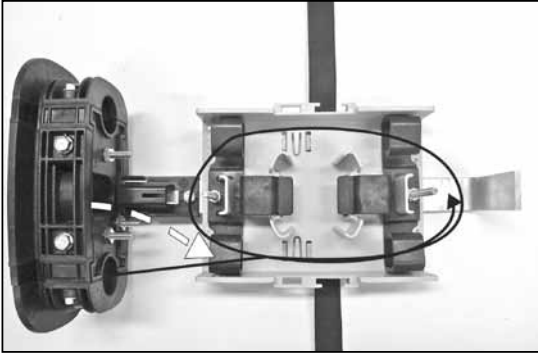
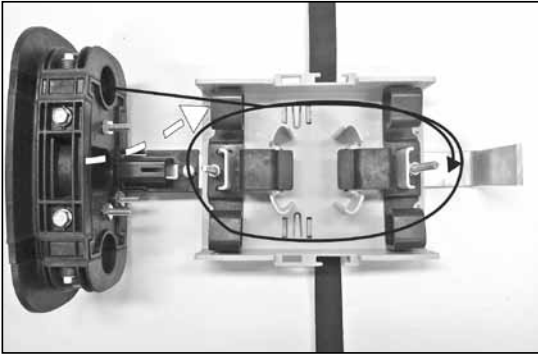

Step #27 Install cover on transition tray.

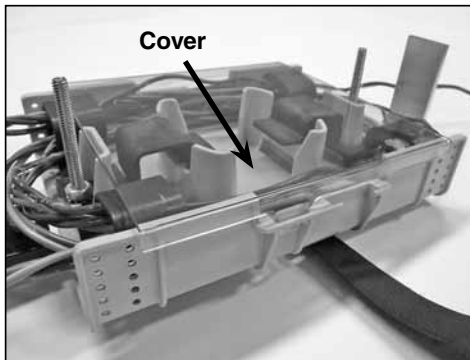

Step #28 Route buffer tube(s) to splice tray(s) and secure.

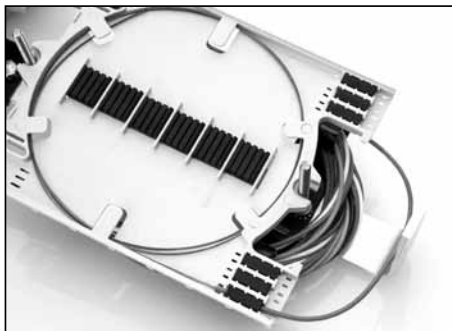

Routing in Universal Organizer for Unitube/Ribbon Applications

Step #29 Remove buffer tube storage brackets from transition tray.

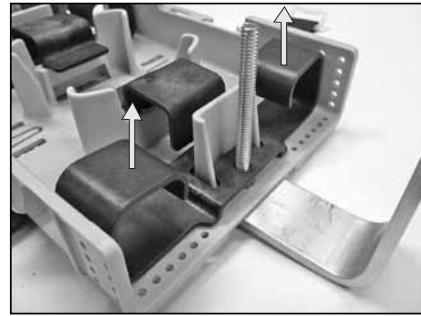

Step #30 Route and secure central tube of unitube cables to transition tray with cable tie wraps.

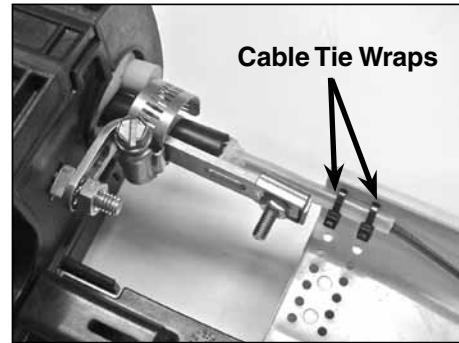

Step #31 Route and store fibers or ribbons within transition tray.

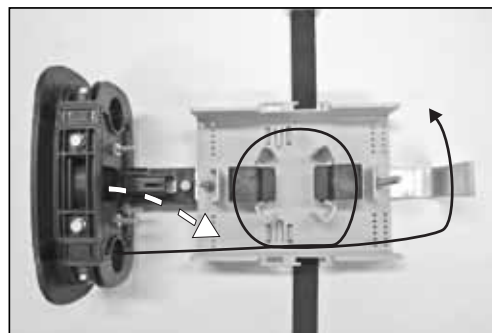
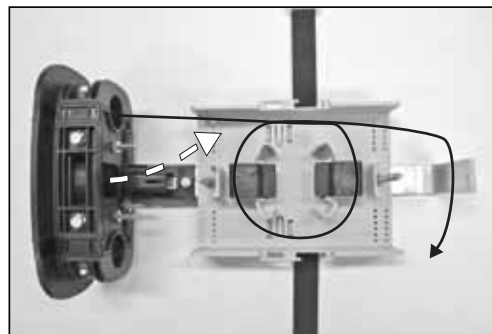

Step #32 Route expressed fibers or ribbons under organizer clips

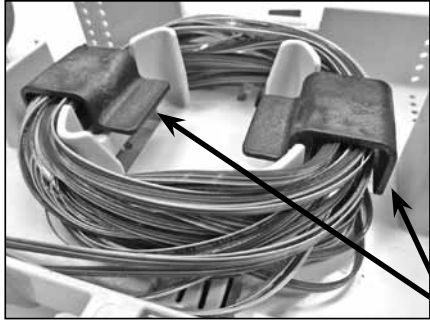

Organizer Clips

Step #33 Insert fibers or ribbons to be routed to splice tray(s) into transport tube(s) and secure tubes to transition tray.



Step #34 Install cover on transition tray.

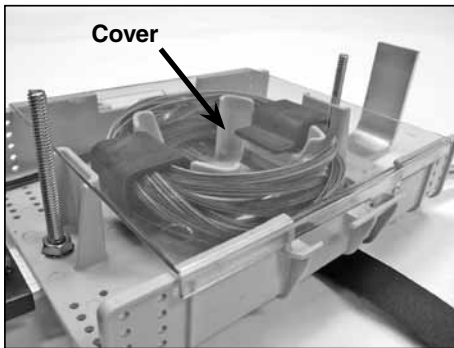

Step #35 Route transport tube(s) to splice tray(s) and secure.

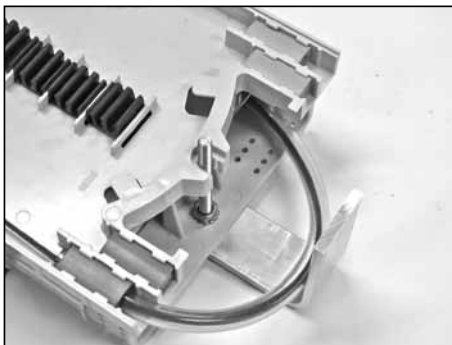

Step #36 If buffer tubes need to be routed to splice trays, install buffer tube side storage clips to route buffer tubes.

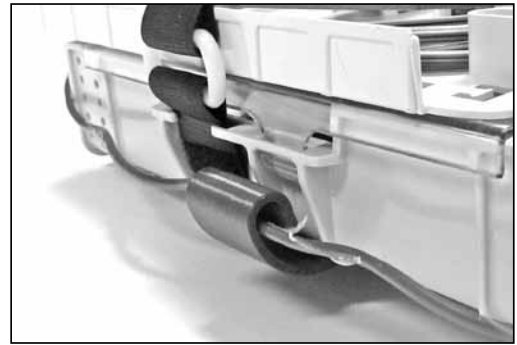
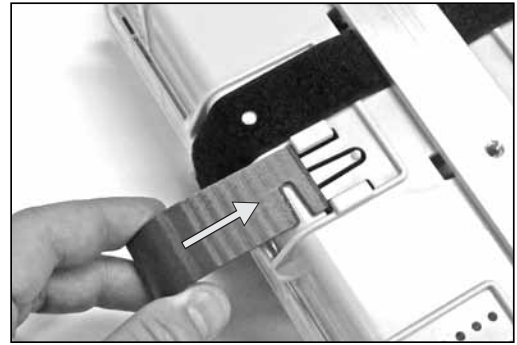

Splice Tray Management

Step #37 Route incoming fibers in splice tray.

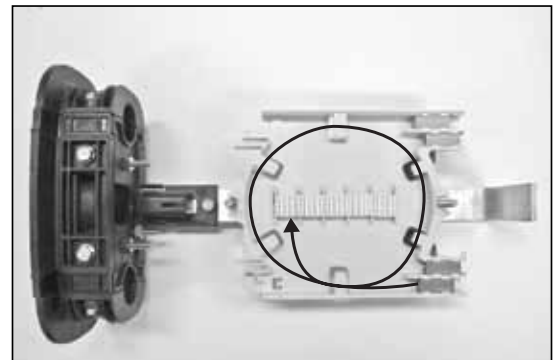

Step #38 Route outgoing fibers in splice tray.

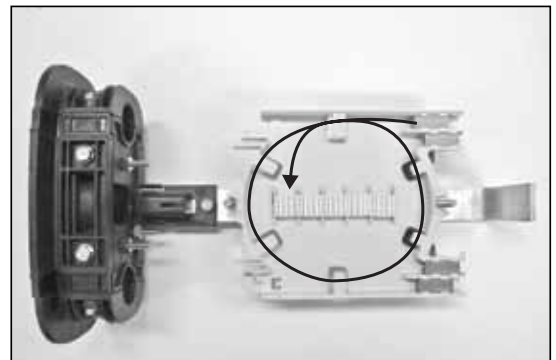

Step #39 Splice incoming fibers to outgoing fibers per your accepted company practices.

Step #40a Secure splice tray(s) in buffer tube organizer with plastic hold down strap.

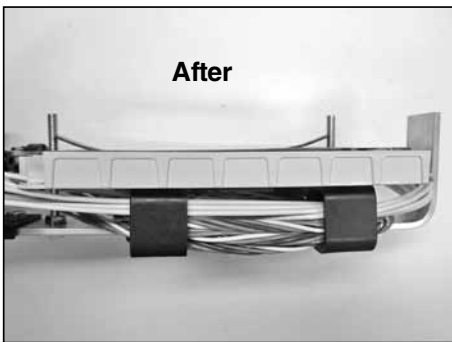
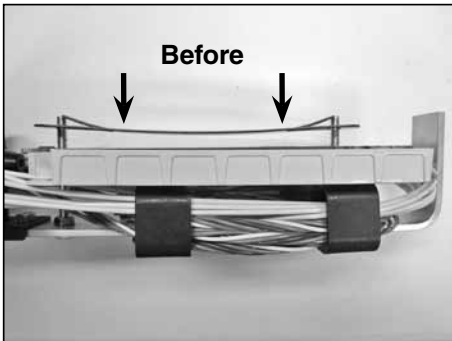

Step #40b Secure splice tray(s) in universal organizer with VELCRO® strap.

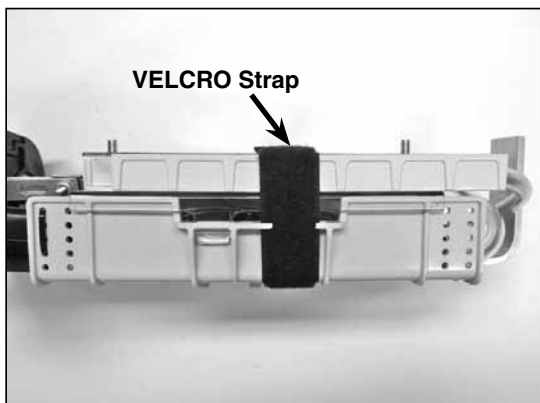

Cross-Connect Applications

Step #41 Measure and mark pigtail. Remove the pigtail jacket and Kevlar® beyond this mark.

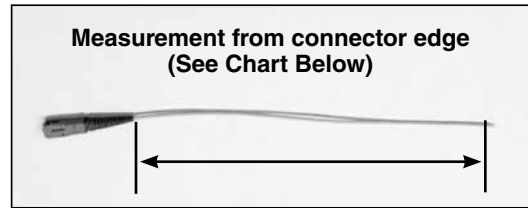

For 6 or 12 Adapters	For 8 Adapters
Position 1&7 = 16" (41cm)	Position 1 = 16" (41cm)
Position 2&8 = 15" (38 cm)	Position 2 = 15.5" (39 cm)
Position 3&9 = 14" (36 cm)	Position 3 = 15" (38 cm)
Position 4&10 = 13" (33 cm)	Position 4 = 14.5" (37 cm)
Position 5&11 = 12" (31 cm)	Position 5 = 14" (36 cm)
Position 6&12 = 11" (28 cm)	Position 6 = 13.5" (34 cm)
	Position 7 = 13" (33 cm)
	Position 8 = 12.5" (32 cm)

Step #42 Install pigtails into LITE-GRIP® 2-Hole Sleeve or bundle up to 6 pigtails together with felt.

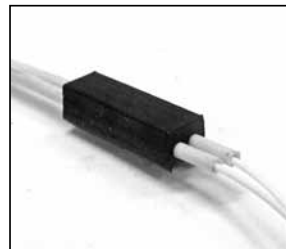

**Pigtails in 2-Hole
LITE-GRIP® Sleeve**



**Pigtails wrapped
with felt**

Step #43 Install LITE-GRIP® Sleeve(s) with pigtails into splice tray or tie wrap pigtails bundled together to splice tray.

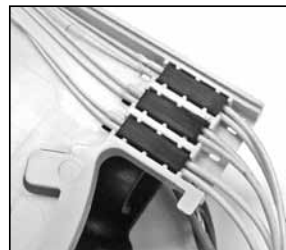

**Pigtails in 2-Hole
LITE-GRIP® Sleeves**

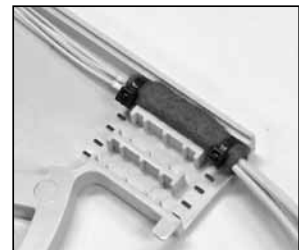

**Tie Wrapped
Pigtail Bundle**

Pigtail Routing

Step #44 Route pigtails to bulkhead as shown.

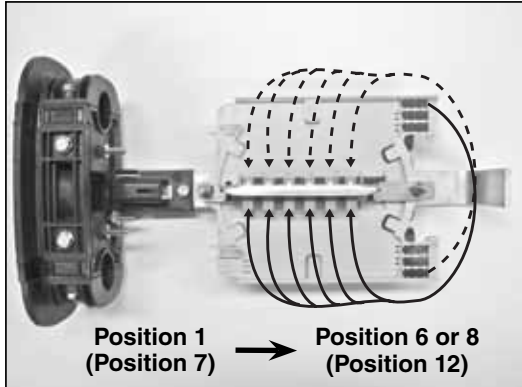

Step #45 Install pigtail connectors into adapters.

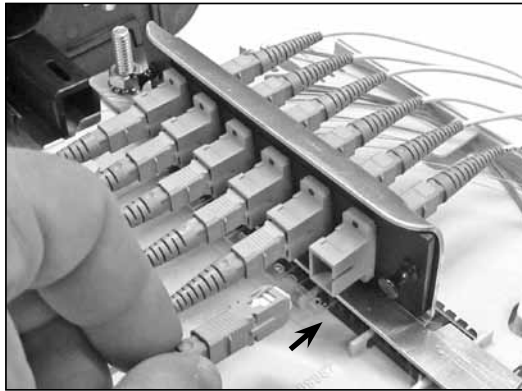

Dome Preparation

Step #46 Lubricate all surfaces around gasket with silicone lubricant to assure easy assembly and closure re-entry.

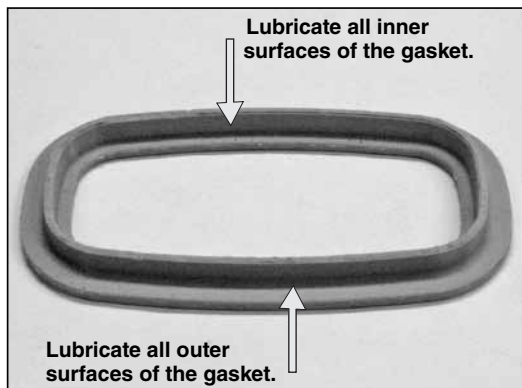

Step #47 Slide end plate gasket onto end plate and press into groove.

Make sure gasket is fully seated in groove of end plate

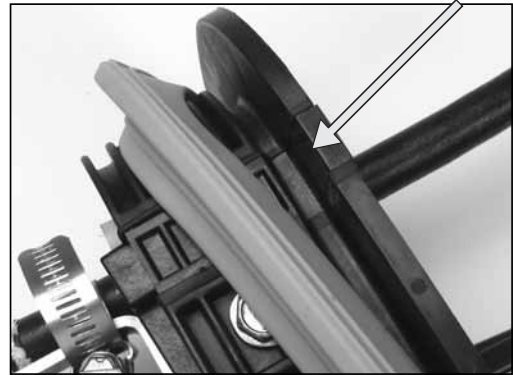

Step #48 Re-tighten all cable cap bolts (Step #21) to assure that the cable caps are fully seated. When using a can wrench or nut driver, the installed torque is 35 to 40 in. lbs.

Step #49 Position dome over end plate.

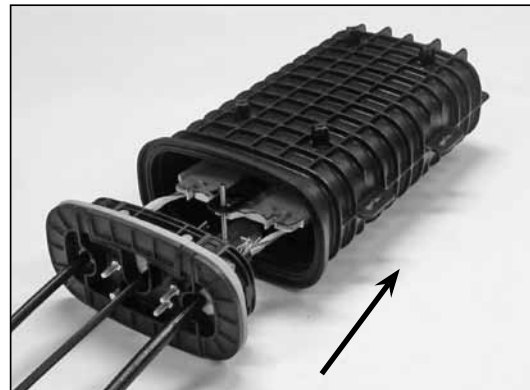

Step #50a Install dome collar.



Step #50b Make sure lip of dome is captured underneath the collar before securing the latch.

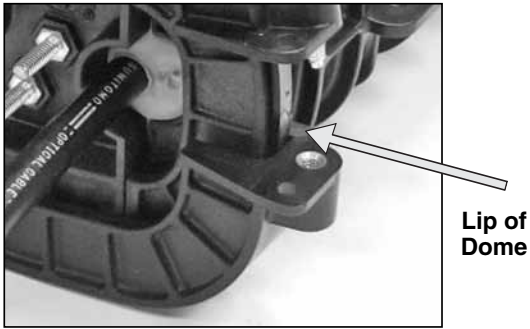

Step #51 Fasten collar by screwing retention bolt by hand or with 7/16" end of a can wrench.

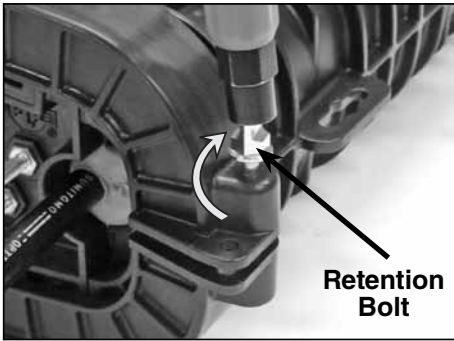
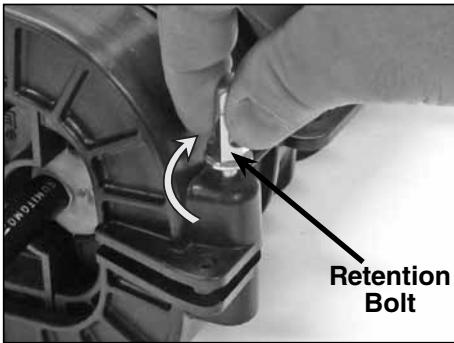

PLP Tip: Secure collar by placing a tie wrap or some other locking device in the hole of the collar flange

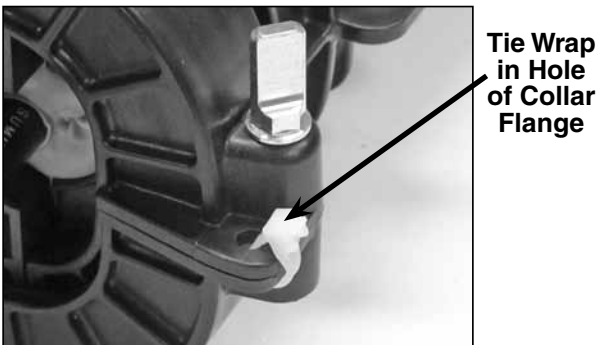

Flash Test Procedure

Step #52 Remove cap from air valve of end plate.



Step #53 Pressurize closure up to a max of 5 psi.

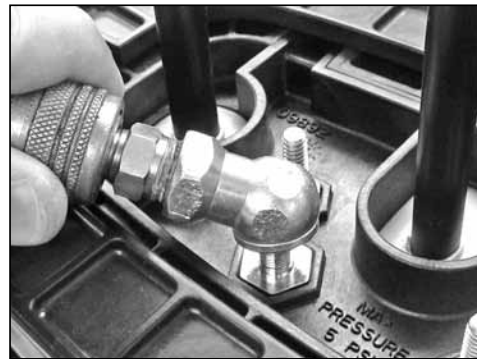

Step #54 Spray all sealing surfaces of the dome end plate with soapy water to determine if there are any leaks



Step #55 Release the pressure in the closure using the bump on the top of the air valve cap.

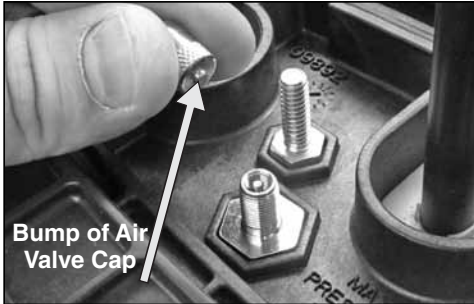

Bump of Air Valve Cap



Common End Plate Leaks During Flash Testing

Leak occurring at the corner of the cable port due to the cap of the cable port not being fully tightened.

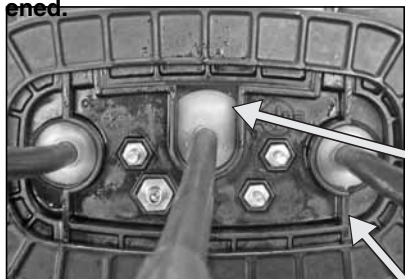

Leak occurring at the corner of the cable port

To resolve, remove collar, remove End Plate/Organizer Assembly from the Dome, and tighten bolts on end cap where leak occurred. Reassemble and flash test to confirm that the leak has stopped.

Leak occurring at the cable entry of the grommet due to the cable not being within the stated cable diameter range of the grommet.



Leak occurring at the cable entry of the grommet

To resolve, remove collar, and remove End Plate/Organizer Assembly from the Dome. Remove end cap where leak occurred, remove grommet, remeasure cable with measure tape provided and select proper grommet. Reassemble the components and flash test the closure to confirm that the leak has stopped.

Aerial Mounting Options - Strand

Step #56 **COYOTE ONE Low Clearance Aerial Bracket for Strand Mounting (Cat. No. 8004005).** Assemble each bracket as shown in photo below and attach the brackets to the dome cover with the self tapping screws.

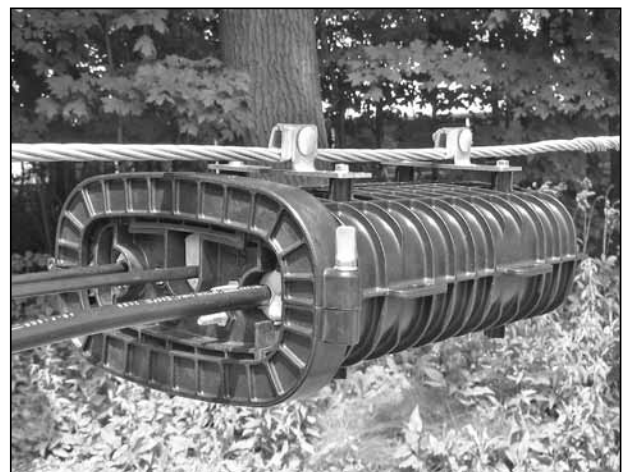
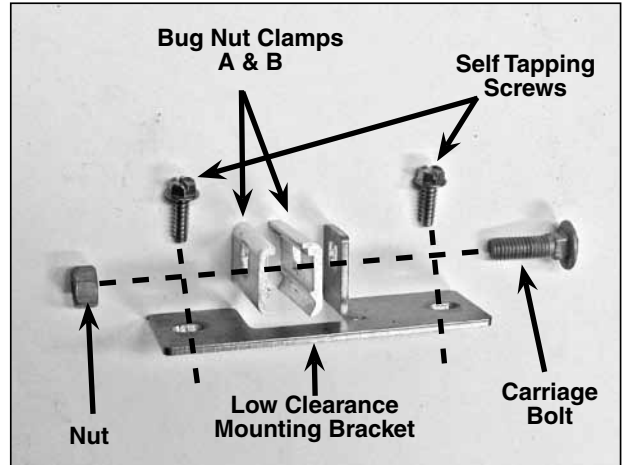

Aerial Mounting Options - Strand

Step #57 COYOTE ONE Adjustable Offset Aerial Bracket for Strand Mounting (Cat. No. 8004027). Assemble each bracket as shown in photo and attach the brackets to the dome cover with the self tapping screws.

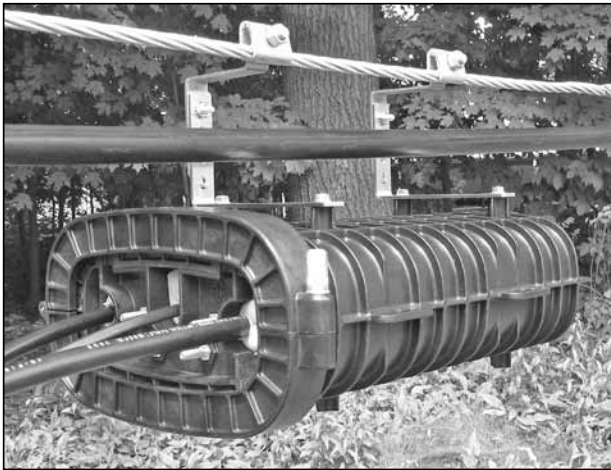
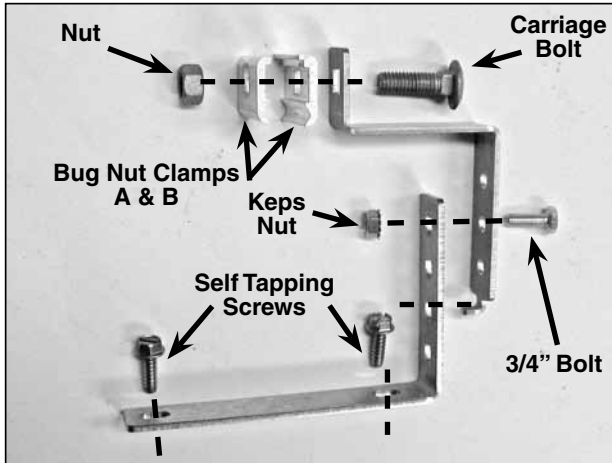

Aerial Mounting Options - ADSS

Step #58 COYOTE ONE Low Clearance Aerial Bracket for ADSS Mounting (Cat. No. 8004031). Assemble each bracket as shown in photo below and attach the brackets to the dome cover with the self tapping screws.

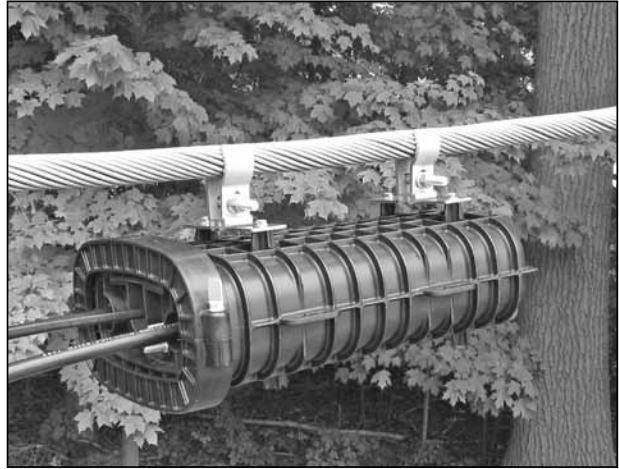
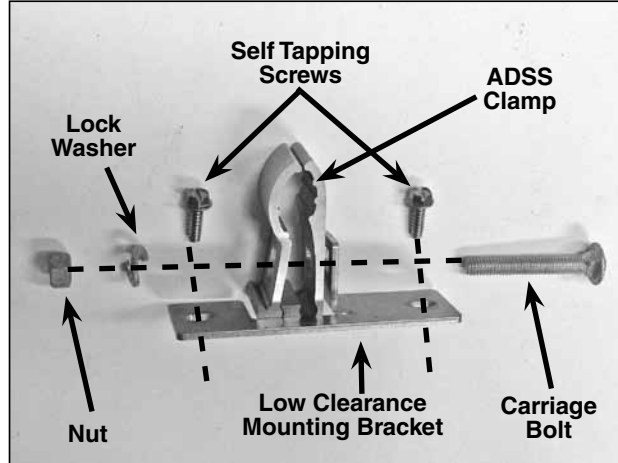

Aerial Mounting Options - ADSS

Step #59 **COYOTE ONE Adjustable Offset Aerial Bracket for ADSS Mounting (Cat. No. 8004032).** Assemble each bracket as shown in photo and attach the brackets to the dome cover with the self tapping screws.

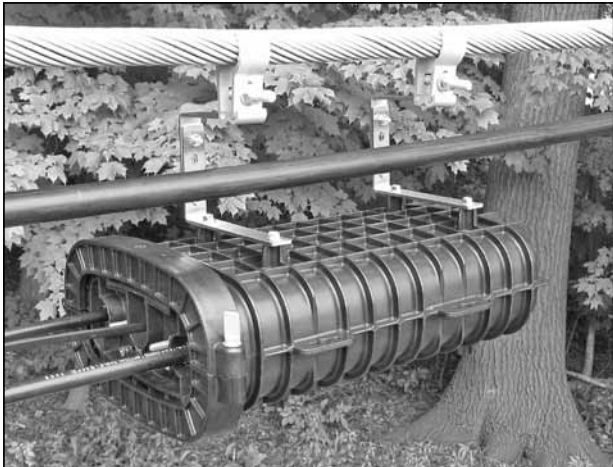
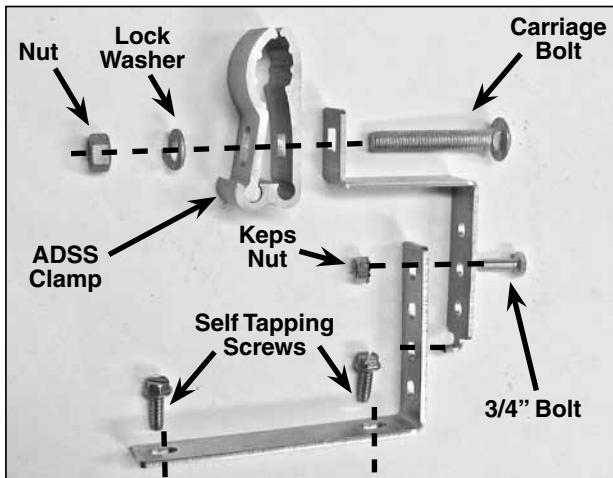

Pole/Wall Mounting Options

Step #60 **COYOTE ONE Closure Pole/Wall Mounting Bracket (Cat. No. 8004004).** Install the end plate mounting plate by placing the mounting plate on the end plate studs and securing with the keps nuts provided as seen below. Install the dome mounting plate to the dome with self tapping screws as seen below. Attach the mounting plates to a pole or wall with either 5/16" lag screws or banding (not provided).

End Plate Mounting Plate

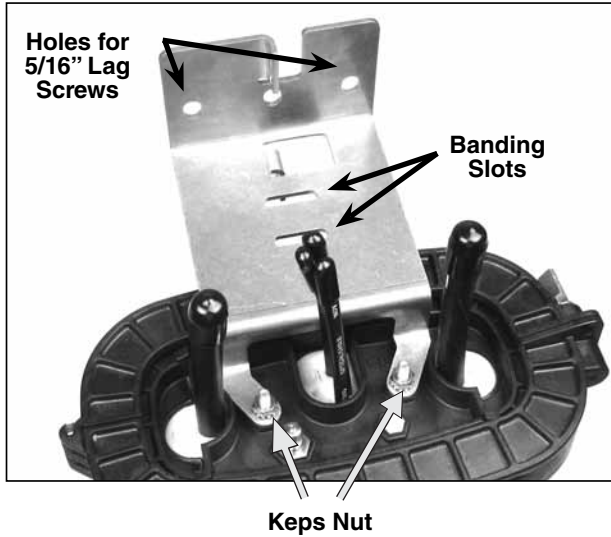

Dome Mounting Plate

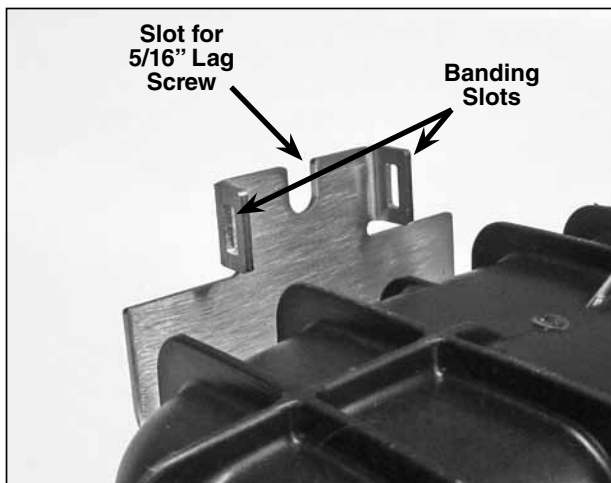
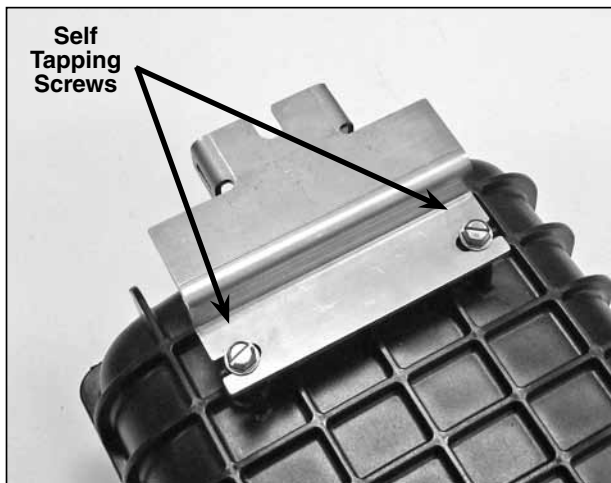

Hand Hole Mounting Options

Step #61 COYOTE Universal Mounting Bracket for Hand Hole Applications (Cat. No. 8003835).

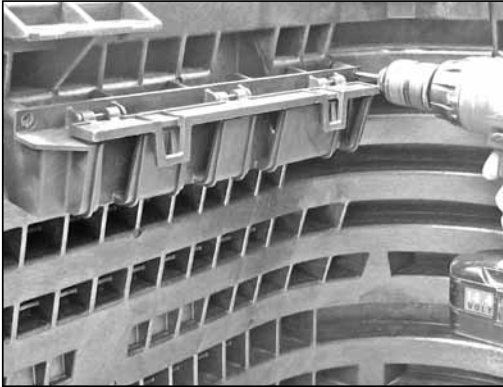

1. Secure the Universal Mounting Bracket to the inner wall of the hand hole using the 2 screws provided.

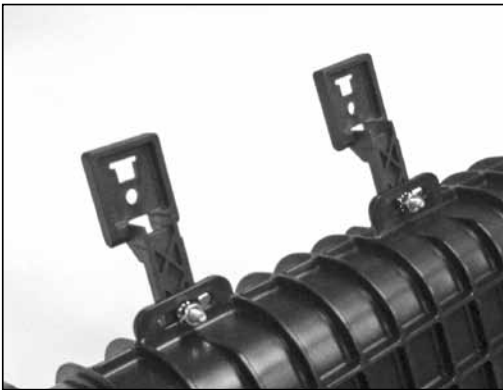

2. Secure the hanger brackets to the ears of the COYOTE ONE with the hex head bolts and keps nuts provided.

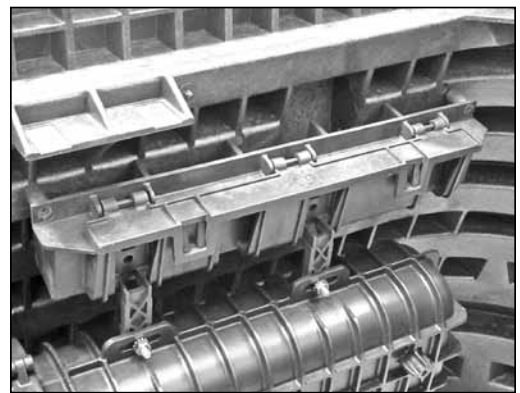
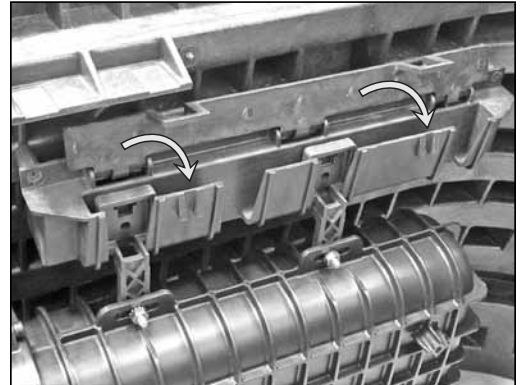

3. Slide the hanger brackets into the proper slots of the Universal Mounting Bracket and snap the hinged lid into place to secure the hanger brackets.

SAFETY CONSIDERATIONS

This application procedure is not intended to supersede any company construction or safety standards. This procedure is offered only to illustrate safe application for the individual. **FAILURE TO FOLLOW THESE PROCEDURES MAY RESULT IN PERSONAL INJURY OR DEATH.**

Do not modify this product under any circumstances.

This product is intended for use by trained technicians only. **This product should not be used by anyone who is not familiar with, and not trained to use it.**

When working in the area of energized lines, extra care should be taken to prevent accidental electrical contact.

For proper performance and personal safety, be sure to select the proper size PREFORMED™ product before application.

PREFORMED products are precision devices. To insure proper performance, they should be stored in cartons under cover and handled carefully.



PREFORMED LINE PRODUCTS

P.O. Box 91129, Cleveland, Ohio 44101 • 440.461.5200 • www.preformed.com • e-mail: inquiries@preformed.com

SP3114-3